

LICHT 2018

Machen Sie Ihr Leben bunter

– für ein strahlend schönes Wohnen

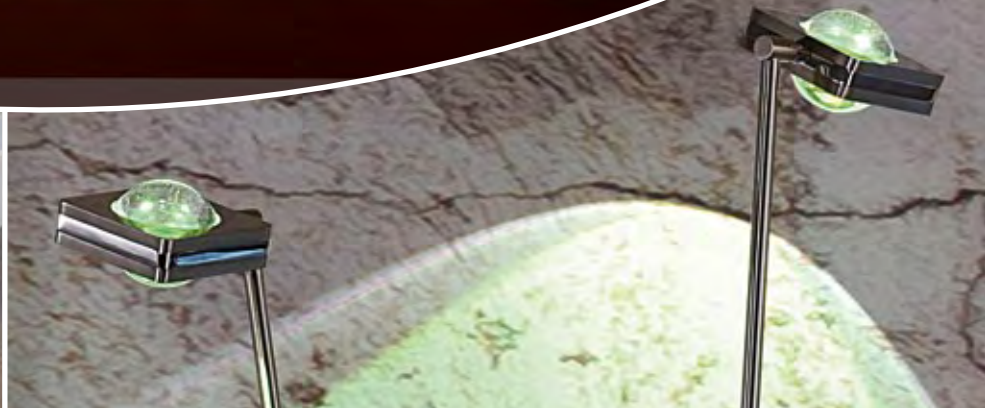



2622431.*
Alu gebürstet, Acryl Weiß
EEK: A+
20 W, LED
3000 K, 1900 lm
H 900-1500, B 800, T 25
höhenverstellbar
€ 140,30



2616182.*
Nickel matt / Chrom,
Acrylglas Weiß
EEK: A+
15 W, LED
3100 K, 2620 lm
L 620, B 370
dimmbar
€ 371,60

2616196.*
Nickel matt / Chrom,
Acrylglas Weiß
EEK: A+
20 W, LED
3100 K, 3840 lm
H 1590, B 140
mit Dimmer an der Leuchte
€ 545,10

2616193.*
Nickel matt / Chrom,
Acrylglas Weiß
EEK: A+
20 W, LED
3100 K, 3840 lm
L 1150, B 140
dimmbar,
höhenverstellbar
€ 495,50



2622390.*
Stahl
EEK: A+
2 x 12 W, LED
3000 K, 1025 lm
H 1360, L 200, B 200
inkl. Schnurschalter
€ 356,80

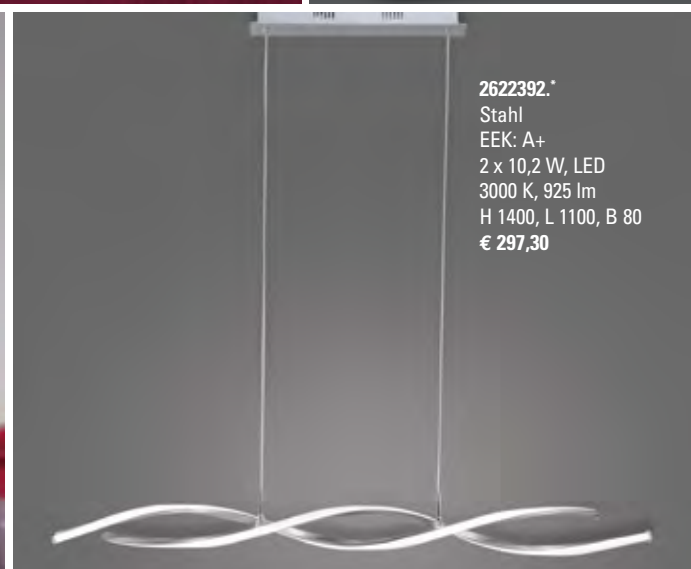

2622392.*
Stahl
EEK: A+
2 x 10,2 W, LED
3000 K, 925 lm
H 1400, L 1100, B 80
€ 297,30



2616153.*
Weiß matt
EEK: A++ bis A
7 W, LED
3000 K, 580 lm
H 60, B 160
A 145
€ 213,00

o. Abb.
2616154.*
Aluminium matt
€ 213,00



2622393.* Stahl, EEK: A+
2 x 10,2 W, LED
3000 K, 925 lm
H 156, L 1100, B 80
€ 297,30



2622394.* Stahl, EEK: A+
4 x 6,75 W, LED
3000 K, 575 lm
H 140, L 780, B 780
€ 297,30



2622391.* Stahl
EEK: A+
LED 7,2 W + LED 4,8 W
3000 K, 372 lm
3000 K, 248 lm
H 485, L 125, B 125
inkl. Touchdimmer
€ 118,80

2622411.*
EEK: A+
4,5 W, LED
3000 K, 520 lm
H 120, A 130, B 80
€ 38,70



6870235.*
EEK: A+
4,5 W, LED
3000 K, 1560 lm
H 430, A 130, B 80
€ 96,00



Nickel matt / Chrom, Acrylglas Weiß matt,
Rand klar

2622408.*
EEK: A+
4,5 W, LED
3000 K, 1040 lm
H 280, A 130, B 80
€ 64,80



2615083.*
Chrom Glas, Weiß matt
EEK: A+
4 W, LED
3000 K, 360 lm
H 150, B 130, A 70
mit Schalter
€ 86,50



2623299*
Weiß, Keramik
EEK: A++ bis E
max. 46 W Eco
H 130, B 315, A 80
€ 103,50



2623301*
Weiß, Keramik
EEK: A++ bis E
max. 46 W Eco
H 120, B 340, A 104
€ 83,30



2616174.*
Nickel matt / Chrom,
Glas satiniert
EEK: A+
4 W, LED, 3000 K, 2880 lm
H 270, D 660
dimmbar
€ 421,20

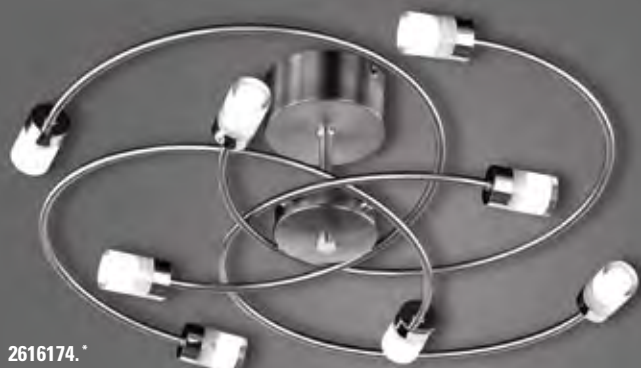

6502099*
Weiß
EEK: A++ bis E
E27, max. 57 W
H 360, B 105
€ 71,10



2616162.*
EEK: A+
42 W, LED
3000 K, 3700 lm
H 190, B 350, L 350
verstellbar, dimmbar
€ 273,70



Weiß und Aluminium

2615099.*
Aluminium matt,
Acrylblende satiniert
EEK: A++ bis A, 6 W, LED
3000 K, 510 lm
B 130, L 270, A 65
€ 198,10



2612060.* Nickel satiniert
EEK: A+, 12 W, LED
3000 K, 1200 lm
H 70, L 350, A 150
€ 184,40



2615044.*
EEK: A+
12 W, LED
3000 K, 1000 lm
H 145, B 250, L 250
verstellbar
€ 136,80

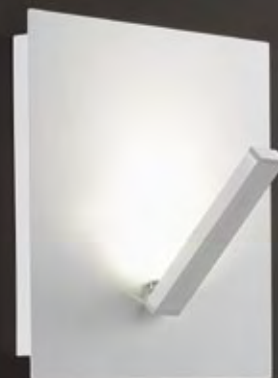

2623304.*
Nickel matt
EEK: A
5,1 W, LED
2700 K, 125 lm
H 265, B 300, A 185
€ 235,60



2622379.*
Stahl
EEK: A+
5 x 5 W, LED
2700-5000 K, 450 lm
H 1800, L 1000, B 120
inkl. Sensorschalter
(ON/OFF), inkl. Sensor für
3-Stufen-CCT und
stufenloses Dimmen;
(2700 - 3800 - 5000K)
€ 208,10



2615117.*
Stahl
EEK: A++ bis A
1 x 28 W LED,
1 x 3,5 W LED
3000 K, 2200 lm /
3000 K, 220 lm
H 1810, B 280, L 370
inkl. Ein/Aus Schalter,
inkl. Drehdimmer
€ 258,50



2602010.*
Nickel matt
Glas Weiß
EEK: A++ bis E
E27, max. 77 W
H 1050-1400, A 430
verstellbar
€ 185,60

2622476.*
Nickel matt
Chrom,
Acrylglas satiniert
EEK: A++ bis A
3 x 9 W, LED
3000 K, 3 x 960 lm
L 1000
höhenverstellbar
von 950-1550 mm
dimmbar
€ 545,20

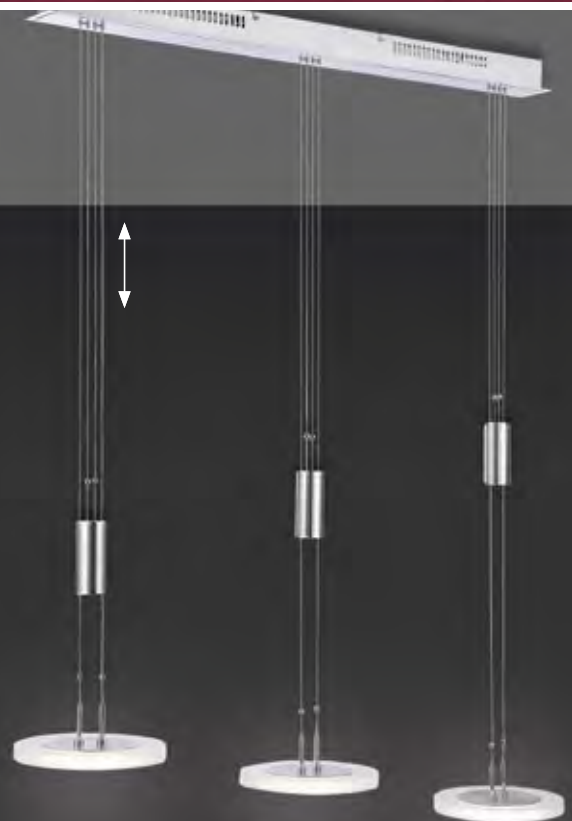

2604243.*
EEK: A++ bis E
E27, max. 46 W
H 90, D 330
€ 56,40



Glas Weiß,
Rand transparent

2604242.*
EEK: A++ bis E
E27, max. 46 W
H 150, L 300, A 90
€ 40,40



Nickel matt, Glas mattiert und klar

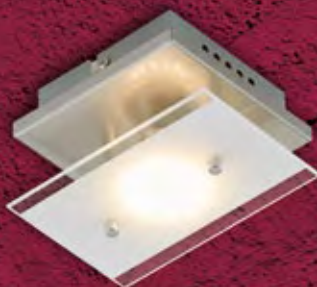

2623295.*
EEK: A+
3 W, LED, GU 10
3000 K, 250 lm
H 120, B 150, A 90
€ 27,80

2623296.*
EEK: A+
2 x 3 W, LED, GU 10
3000K, 2 x 250 lm
H 120, B 270, A 90
€ 49,80



2622475.*
Chrom, Acrylblende satiniert
EEK: A++ bis A
3 x LED, 4,5 W
3000 K, 3 x 464 lm
H 50, L 700, B 110
€ 98,90



2615025.* Edelstahl matt
EEK: A++ bis A, 13 W, LED
3000 K, 1200 lm
H 90, B 260, T 70
€ 202,10



2615534.*
Nickel matt,
Glas satiniert/klar
EEK: A++
3 x 4,5 W, LED
3000 K, 430 lm
H 950-1500
B 870, T 100
höhenverstellbar
€ 140,30



2616152.*
Aluminium matt
EEK: A++ bis A
9 W, LED
2900 K, 900 lm
H 70, D 100
dimmbar
€ 177,30

o. Abb.
2616151.*
Weiß matt
€ 177,30

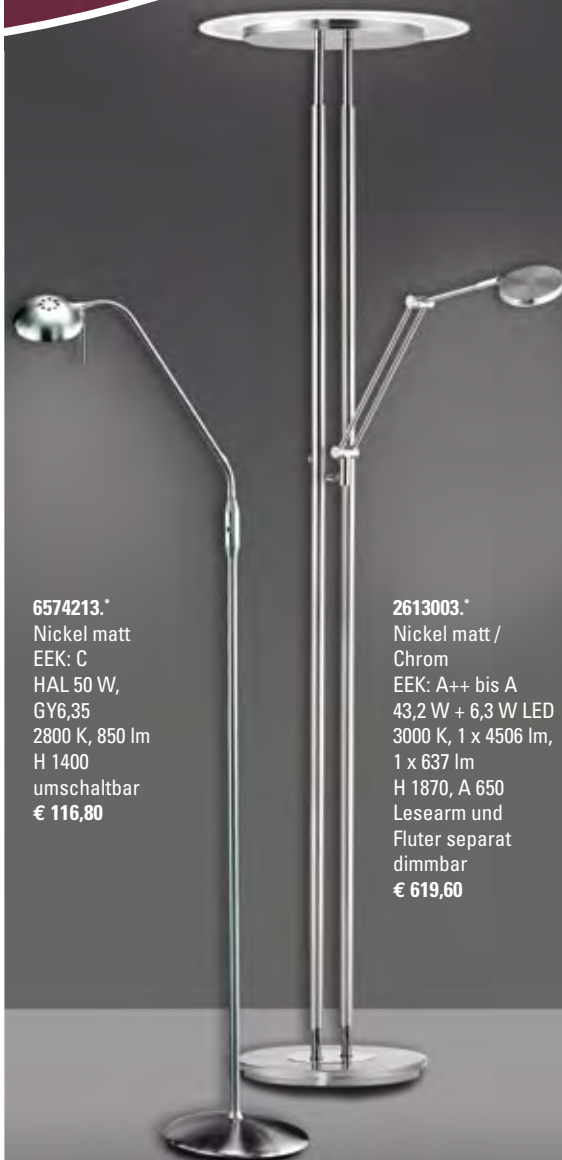

6574213.*
Nickel matt
EEK: C
HAL 50 W,
GY6,35
2800 K, 850 lm
H 1400
umschaltbar
€ 116,80

2613003.*
Nickel matt /
Chrom
EEK: A++ bis A
43,2 W + 6,3 W LED
3000 K, 1 x 4506 lm,
1 x 637 lm
H 1870, A 650
Lesearm und
Fluter separat
dimmbar
€ 619,60



2623173*
Filz grau
EEK: A++ bis E
3 x E14, max. 30 W
H 120, D 400
€ 123,70

2623180*
Nickel matt,
Schirm Filz grau
EEK: A++ bis E
2 x E27, max. 46 W
H 140, L 800, B 250
€ 148,50



2622469.*
Weiß, Cappuccino, Gold
EEK: A+
18 W, LED, 3000 K, 1380 lm
H 100, D 405
€ 135,00

2623118*
Stahl Nickel matt,
Cappuccino, Gold
EEK: A++ bis E
3 x E27, 46 W
H 1100 D 530
€ 121,90



2606016*
Nickel matt
EEK: A++ bis E
2 x E27, max. 46 W
H 160, D 280
€ 74,30

verwendbar als Wand-
oder Deckenleuchte

2622468*
Stahl Nickel matt,
Cappuccino, Gold
EEK: A++ bis E
2 x E27, max. 46 W
H 1100, B 250,
L 1000
€ 160,80



2622531.*
Stahl gebürstet
EEK: A++ bis A
4 W, LED
2700 K, 270 lm
H 140, B 100,
T 90
€ 66,60



2622532.*
Weiß
EEK: A++ bis A
4 W, LED
2700 K, 270 lm
H 140, B 100,
T 90
€ 66,60

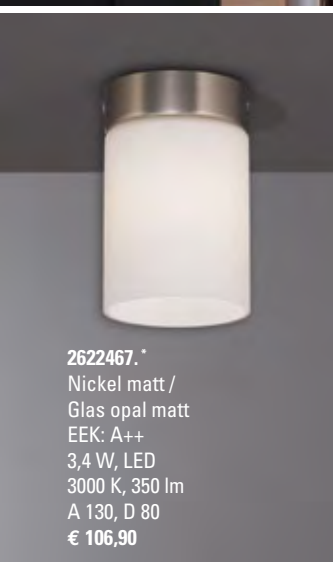

2622467.*
Nickel matt /
Glas opal matt
EEK: A++
3,4 W, LED
3000 K, 350 lm
A 130, D 80
€ 106,90



2622413.*
Aluminiumfarbig,
Acrylglas Weiß
EEK: A+
5,9 W, LED
3000 K, 550 lm
H 60, B 200, A 110
€ 64,80



2603532*
Nickel matt
Glas Opal
glänzend
EEK: A++ bis E
2 x E14, max. 46 W
H 420, B 190, A 90
€ 139,40

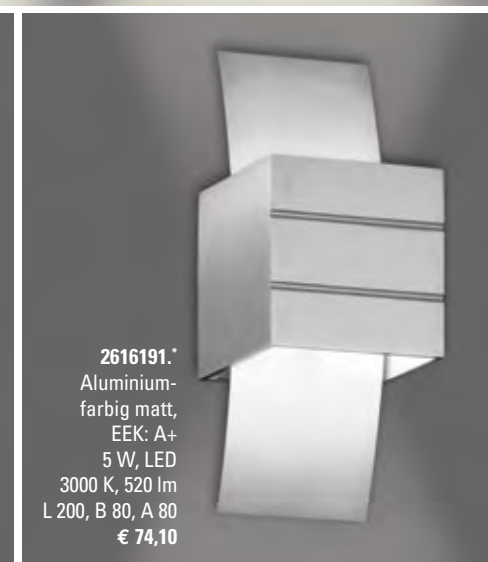

2616191.*
Aluminium-
farbig matt,
EEK: A+
5 W, LED
3000 K, 520 lm
L 200, B 80, A 80
€ 74,10

2615016.*

Weiß
EEK: A++ bis E
E27, max. 57 W
D 195,
Pendellänge 1300
€ 83,10



2615017.*

Aluminium gebürstet
EEK: A++ bis E
E27, max. 57 W
D 195,
Pendellänge 1300
€ 106,90



2623263.*

Nickel matt
EEK: A+
3 x 12 W, LED
3000 K, 3 x 1050 lm
H 1500, B 1050, T 100
mit Gestendimmer
€ 318,70



0644820.*

Chrom,
Glas klar / satiniert
EEK: A+
5 x 4,5 W, LED
3000 K, 400 lm
H 80, B 380, L 380
€ 164,20



2616150.*

Alu gebürstet, Glas satiniert
EEK: A+
4 x 3,3 W, LED
3000 K, 1360 lm
H 55, B 270, L 270
LED tauschbar
€ 108,00



2622452.*

Struktur Weiß
EEK: A++ bis A
2 x 4,6 W, LED
3000 K, 2 x 470 lm
L 160, B 130, A 110
schwenkbar, dimmbar
€ 178,30



2623181.*

Aluminiumfarbig,
Acrylglas Weiß matt
EEK: A++ bis A
33,7 W, LED
3000 K, 3940 lm
L 1130, H 1000-1600
Dimmer an der Leuchte
höhenverstellbar
€ 309,70

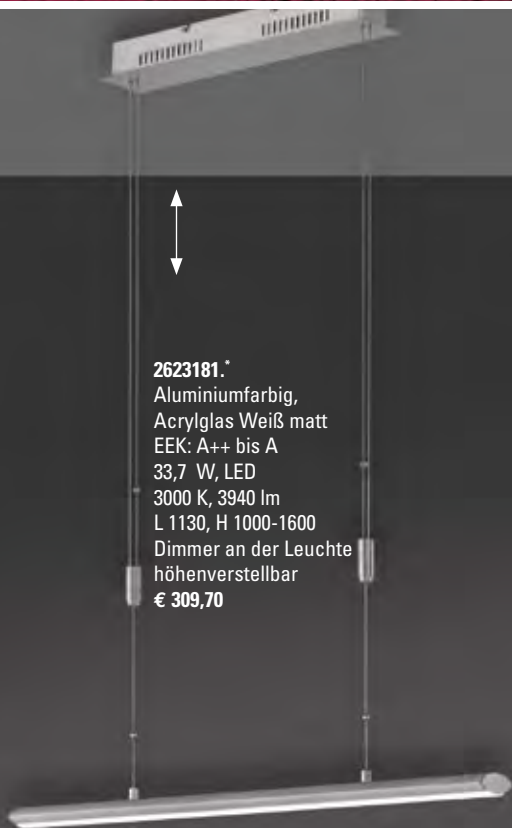

2622430.*

Alu gebürstet
EEK: A+
45 W, LED
3000 K, 4500 lm
H 1200, B 1150,
T 80
mit 4-fach Touch-
Dimmer
€ 254,70

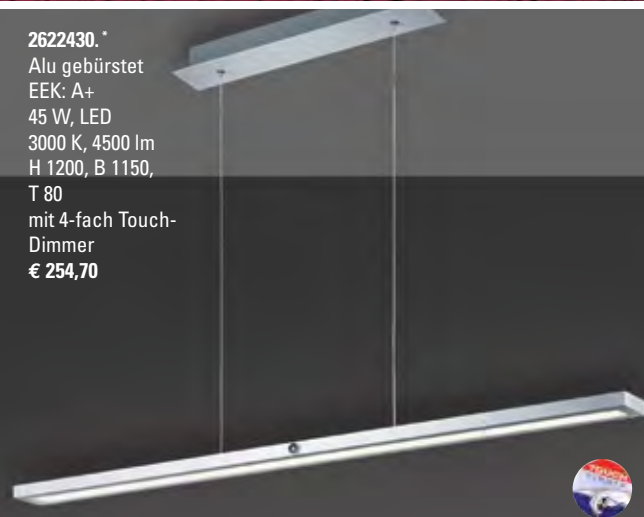

2622439.*

Alu gebürstet
EEK: A+
24 W, LED
3000 K, 2400 lm
H 60, B 800, T80
dimmbar
€ 197,60





SMART
HOME
LIGHTS

Jede Q®-Leuchte auf dieser Doppelseite wird mit einer Q®-Fernbedienung geliefert und kann damit sowohl gedimmt als auch in allen Farbnuancen zwischen Rot-Grün-Blau und Weiß eingestellt werden.

Licht schafft Atmosphäre. Q® Smart Home Lights basiert auf der besonders energieeffizienten LED-Technologie und macht intelligente Lichtsteuerung ganz easy.

2623258.*

Stahl, Kugel: Glas
EEK: A+
2 x 3 W
3000 K, 310 lm
H 145, L 110, B 110
drehbar um 320°
€ 224,90

2623233.*

Stahl, Kugel: Glas
EEK: A+
2 x 3 W
3000 K, 310 lm
H 410, L 230, B 230
inkl. Schnurschalter
inkl. Kugelgelenk
€ 267,60

Titelleuchte

2623229.*

Stahl, Kugel: Glas
EEK: A+
8 x 3 W
3000 K, 4 x 310 lm
H 1200, L 990, B 165
€ 594,80

2623221.*

Chrom
EEK: A+
3 x 3,9 W
2700-5000 K, 400 lm
H 23, L 100, B 100, A 9
Einbaumaß D 68 mm,
je 1500 mm Kabel zwischen
Spot und 6-fach-Verteiler
€ 237,80



2623222.*

Chrom
EEK: A+
1 x 3,9 W
2700-5000 K, 400 lm
H 23, L 100, B 100
Erweiterungsstrahler,
ohne LED-Driver etc.,
1500 mm Kabel
€ 44,50



2623243.* Stahl

EEK: A+
4 x 4,8 W
3000 K, 450 lm,

H 200, L 1190
drehbar, 180° schwenkbar
€ 415,30



2623256.* Stahl

EEK: A+
4,8 W
3000 K, 450 lm
H 745
inkl. Wippschalter und
Zuleitung, drehbar,
180° schwenkbar
€ 237,80



2623232.* Stahl

EEK: A+
4,8 W
3000 K, 450 lm
H 887
inkl. Schnurschalter
€ 205,20

2623244.* Stahl

EEK: A+
6 x 4,8 W
3000 K, 450 lm

H 250, L 1865
drehbar, 180° schwenkbar
€ 593,80

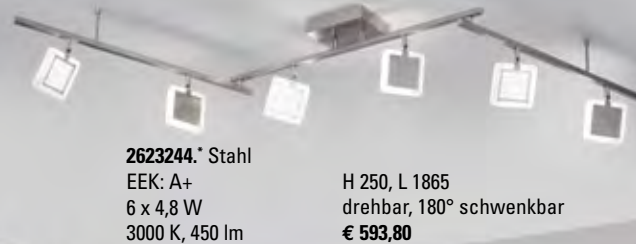

2623231.* Stahl

EEK: A+
24 W / 4,8 W
3000 K, 2950 lm
H 1800,
L 590, B 570
2 Wippschalter,
drehbar
€ 832,70





2623235.*
Stahl, Kugel: Glas
EEK: A+
4 x 3 W
3000 K, 2 x 310 lm
H 1420, L 700, B 420
inkl. Schnurschalter
inkl. Kugelgelenk
€ 535,30



2623224.* mehrfarbig
EEK: A+
25 W
3000 K, 2500 lm
H 3, L 5000, B 10
alle 250 mm kürzbar,
€ 118,80

2623223.* transparent
24 W
2500 lm, 3000-5500 K
alle 125 mm kürzbar,
€ 118,80



Haltetaschen mit Schrauben,
rückseitiges Klebeband, mit
Schnellverbindern wieder
verbindbar, inkl.
4 Verbindungskabel,
inkl. Steckertrafo

Alle Q®-Leuchten können bequem mit der Fernbedienung gesteuert oder in vorhandene Smart-Home-Systeme integriert werden, die auf dem Zig Bee Funkstandard basieren.

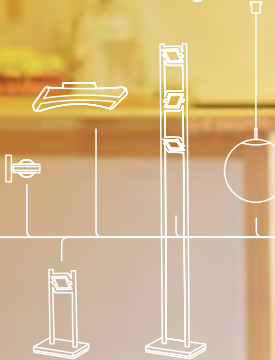

2623246.*
H 110, L 280, B 280
€ 416,30

EEK: A+, 4 x 5 W
3000 K, 450 lm
Aluminium,
inkl. Kugelgelenk, schwenkbar

2623247.*
H 110, L 800, B 120
€ 416,30

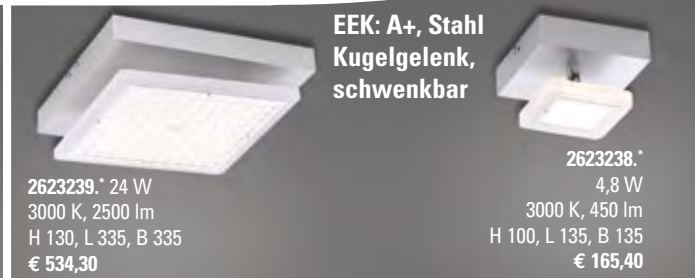

2623239.* 24 W
3000 K, 2500 lm
H 130, L 335, B 335
€ 534,30

EEK: A+, Stahl
Kugelgelenk,
schwenkbar

2623238.*
4,8 W
3000 K, 450 lm
H 100, L 135, B 135
€ 165,40



transparent, EEK: A+
Standardlampe, 650 lm, 180°
H 119, L 60, B 60, Ø 60

o. Abb. **2623213.***
3000 K, 650 lm
Weiß 350 lm, RGB 250 lm
€ 41,50

2623214.*
2er Set Standardlampe
inkl. Fernbedienung
€ 118,90



o. Abb. **2623211.***
2700-5000 K, 650 lm
€ 35,60

2623212.*
2er Set Standardlampe
inkl. Fernbedienung
€ 95,10



2623230.*
EEK: A
2 x 14 W
3000 K, 1500 lm
H 1280, L 1005, B 155
€ 505,60

2623260.*
EEK: A+
2 x 4,2 W
3000 K, 450 lm
H 345, B 105, A 70
inkl. Wippschalter
€ 208,10

Chrom



2623248.*
EEK: A
2 x 14 W
3000 K, 1500 lm
H 85, L 1010, B 130
€ 475,80



2623236.*
EEK: A+
2 x 5,6 W
3000 K, 700 lm
H 435, B 100
€ 223,00

2623253.*
EEK: A
2 x 16,8 W
3000 K, 1600 lm
H 1305, B 140
€ 594,80



2616224.* Weiß, EEK: A+
25 W, LED
3000 K, 2500 lm
H 56, L 300, B 300
€ 260,60

o. Abb. **2616225.*** EEK: A+
30 W, LED
3000 K, 3600 lm
H 56, L 450, B 450
€ 379,60

o. Abb. **2623250.*** EEK: A+
46 W, LED
3000 K, 5200 lm
H 56, L 620, B 620
€ 534,30

o. Abb. **2623251.*** EEK: A+
48 W, LED
3000 K, 5200 lm
H 56, L 1200, B 300
€ 570,00

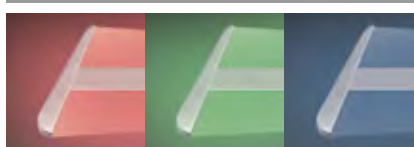



2623188.*
Weiß matt
EEK: A++ bis A
8 W, LED
2800 K, 630 lm
H 55, D 65
dimmbar
€ 105,90

o. Abb.
2623189.*
Aluminium matt
EEK: A++ bis A
€ 105,90



2623187.*
Aluminium matt
EEK: A++ bis A
8 W, LED
2800 K, 630 lm
H 55, B 65, L 65
dimmbar €
€ 117,80

o. Abb.
2623186.*
Weiß matt
EEK: A++ bis A
€ 117,80



2623237.*
Stahl
EEK: A+
1 x 28 W, LED,
1 x 4 W, LED
3000K, 2500 lm
H 1830
dimmbar,
inkl. zwei Tastdimmer
€ 297,30



0644803.*
Nickel matt,
Glas alabaster-
farbig Weiß
EEK: A+
5 x 4,5 W, LED
3000 K, 400 lm
H 1800
mit Schalter und
Drehdimmer
€ 178,10

2622426.*
Alu gebürstet /
Acryl Weiß
EEK: A+
4,5 W, LED
3000 K, 430 lm
H 180, B 130, T 90
mit Schalter
€ 62,50



2622425.*
Weiß matt
EEK: A+
4,5 W, LED
3000 K, 430 lm
H 60, B 105, T 150
€ 76,40



o. Abb.
2622424.*
Nickel matt
€ 76,40

2615047.*
Nickel satiniert,
Diffusorlinse satiniert
EEK: A+
16 W, LED
3000 K, 1400 lm
H 170, B 175, L 100
2facher Lichtaustritt
€ 154,20





4903684.*
Weiß
EEK: A+ bis E
E27, max. 77 W
H 245, D 300
€ 130,90

8403274.*
EEK: A+
Weiß
21 W, LED
3000 K, 1900 lm
H 60, D 360
Pendellänge
200 - 1300
€ 385,50



2623178.*
Nickel matt, Acrylglas Weiß
EEK: A++ bis A
9,7 W, LED
3000 K, 2661 lm
L 1110, B 75,
H 950 - 1600,
höhenverstellbar,
dimmbar
€ 322,10

2616148.* Stahl Chrom,
Glas satiniert / klar
EEK: A, 4 x 3 W, GU10-LED
3000 K, 200 lm
B 290, L 290, A 85
€ 71,00



2612875.* Chrom
Glas teilsatiniert
EEK: A+, 8 x 3,3 W, LED
3000 K, 305 lm
B 270, L 540, A 70
€ 297,30



2616219.* Chrom
EEK: A+
24 W, LED
4000 K, 2400 lm
H 120, B 350, L 350
dimmbar
€ 203,90



2616223.* Stahl
EEK: A+
2 x 19 W LED, 2 x 1,4 W LED
3000 K, 1710 lm
H 50, B 100, L 1100
dimmbar
€ 356,80



2616131.*
Chrom, Acrylglas
EEK: A+
5 W, LED
3000 K, 400 lm
H 170, B 160, A 50
€ 65,90

2616130.*
Chrom, Acrylglas
EEK: A+
5 W, LED
3000 K, 400 lm
H 180, B 195, A 50
€ 65,90

2603883.*
Nickel matt
Glas Weiß gewischt
EEK: A++ bis E
E14, max. 30 W
H 200, D 80
€ 29,50



6502163.*
Nickel satiniert
Glas Opal Weiß
EEK: C, HAL 33 W, G9
H 250, D 100
mit 3-Stufen-
Touchdimmer
€ 62,10



2614899.*
Alu Eloxiert
EEK: A+
2 x 3 W LED, GU 10
3000 K
H 176, D 65
€ 47,30





Nickel satiniert,
Glas Weiß

2622339*
EEK: A++ bis E
3 x E27, max. 40 W
H max. 2000, D 410
€ 307,00

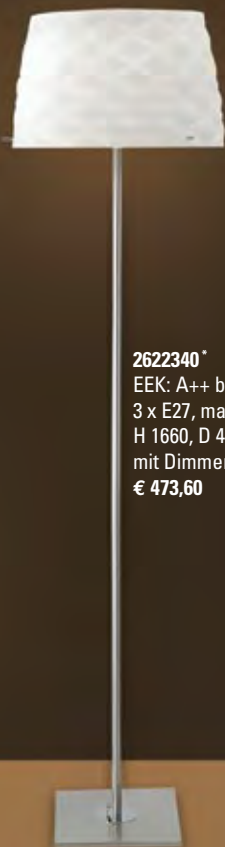

2622340*
EEK: A++ bis E
3 x E27, max. 40 W
H 1660, D 415
mit Dimmer
€ 473,60

2622345*
EEK: A++ bis E
E27, max. 40 W
H 460, D 260
mit 3-Stufen-
Touchdimmer
€ 176,10



2622487*
Chintz melange,
Abdeckung
unten Weiß
EEK: A+
30 W, LED
2700 K, 3500 lm
H 100, D 400
€ 319,80



LED-Module werkzeuglos austauschbar,
einfaches Dimmen mit vorhandenem
Schalter (ohne externen Dimmer)



2616170*
Nickel satiniert,
Glas Opal Weiß
EEK: A+
8 W, LED
3000 K, 720 lm
H 300, D 100
mit 3-Stufen-
Touchdimmer
€ 121,30

2612528*
Glas Opal Weiß
EEK: A++ bis E
E27, max. 57 W
H 240, B 220,
A 90
€ 45,10



2605576*
Nickel matt
Glas satiniert
EEK: A++ bis E
E27, max. 57 W
H 700 - 1500, D 390
Kabellift
höhenverstellbar
€ 151,20

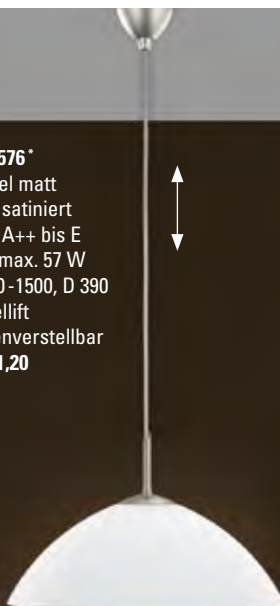

2605025*
Chintz Weiß
EEK: A++ bis E
3 x E27,
max. 57 W
D 450, A 185
€ 285,40

2605021*
Chrom / Chintz Weiß
EEK: A++ bis E
E27, max. 57 W
H 260, D 450,
Pendellänge 1500
€ 249,70



2623162*
Aufhängung Weiß,
Glas Weiß
EEK: A+
18 W, LED
3000 K, 1620 lm
H 250, D 530
dimmbar
€ 273,70

2623161*
Aufhängung Weiß,
Glas Weiß
EEK: A+
18 W, LED
3000 K, 1620 lm
H max. 2000, D 530
dimmbar
€ 283,20



6574533*
Nickel matt
Glas Opal glänzend
EEK: A++ bis E
E27, max. 46 W
H 290, B 210, A 110
€ 35,30



2601811*
Nickel satiniert
EEK: C
HAL 33 W, G9
H 300, L 110, A 100
mit Schalter
€ 88,00



6020210*
 Weiß
 EEK: A++ bis E
 ESL Globe 20 W,
 E27
 D 400, Pendel-
 länge 650-1500
 höhen-
 verstellbar
 € 106,90



6066001*
 Weiß /
 Prismatikwanne
 EEK: A++ bis E
 Ringröhre 40 W
 H 500, D 490
 € 118,80



2600377*
 Nickel matt
 Glas alabaster Weiß
 EEK: A++ bis E
 E27, max. 57 W
 H 700-1500, D 400
 Kabellift
 höhenverstellbar
 € 151,20

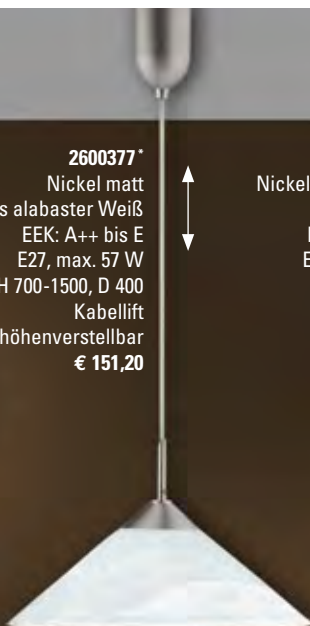

2612101*
 Nickel matt / Chrom,
 Glas Weiß
 EEK: A++ bis E
 E14, max. 30 W
 L 1250,
 Glas D 110
 € 39,40

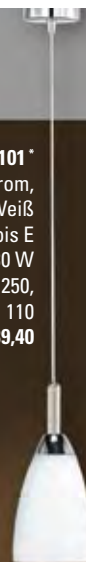

2622342.*
 Nickel satiniert /
 Aluminium,
 Glas transparent,
 Diffusorlinse satiniert
 EEK: A+
 12 W, LED
 3000 K, 1080 lm
 H 1000-1800, D 400
 Zugpendel
 höhenverstellbar
 dimmbar
 € 211,80

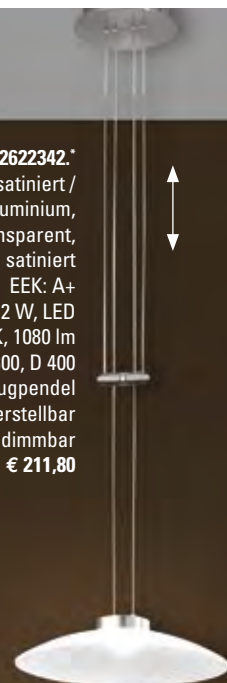

2616250.*
 Aluminium matt,
 Acrylblende satiniert
 EEK: A++ bis A
 6 x 4,2 W, LED
 2700 K, 6 x 452 lm
 H 950-1500, L 1100
 höhenverstellbar
 dimmbar
 € 297,30

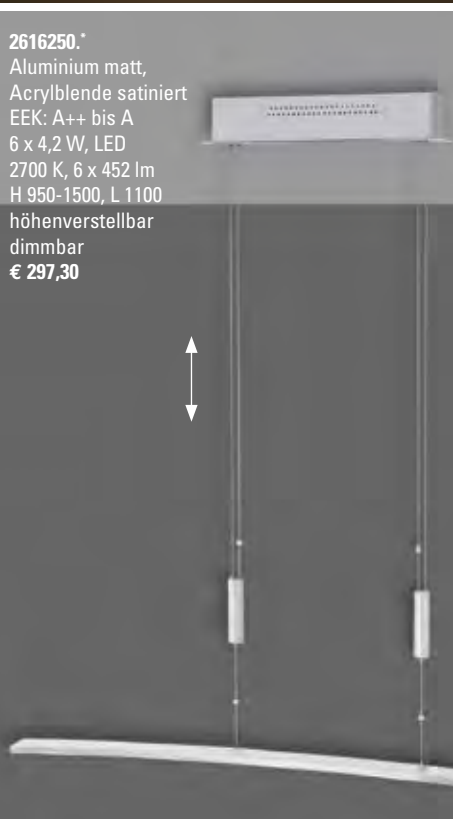

2623149.*
 Stahl chrom,
 Kunststoff klar,
 satiniert
 EEK: A+
 4 x 4,5 W, LED
 3000 K, 1920 lm
 H 1100, B 90, T 780
 LED tauschbar €
 € 121,90

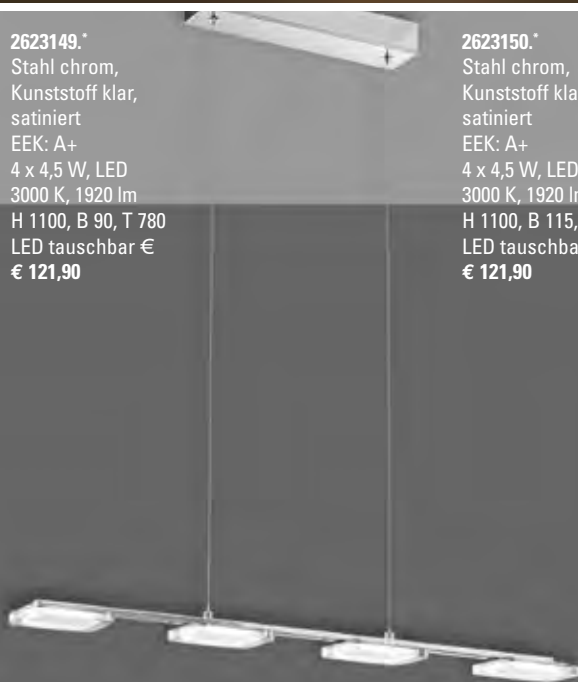

2623150.*
 Stahl chrom,
 Kunststoff klar,
 satiniert
 EEK: A+
 4 x 4,5 W, LED
 3000 K, 1920 lm
 H 1100, B 115, T 775
 LED tauschbar €
 € 121,90



0644775.*
 Aluminium
 gebürstet
 EEK: A++
 2 x 3,2 W, LED
 3000 K, 2 x 300 lm
 H 60, B 300, A 80
 € 82,10

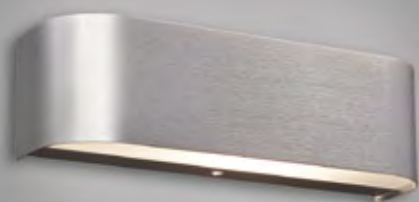

o. Abb.
0644774.*
 Weiß,
 Glas satiniert
 EEK: A++
 € 82,10

2616147.*
 Stahl Chrom, Weiß, klar
 EEK: A+
 3 x 3 W, GU10-LED
 3000 K, 3 x 200 lm
 H 130, L 415, A 85
 € 57,00



2622470.*
 Alu gebürstet, Glas satiniert
 EEK: A+
 2 x 3,3 W + 2 x 5,4 W, LED
 3000 K, 1700 lm
 B 270, L 270
 € 134,00





6020216*
Titan / Silber
Glas Opal matt
EEK: A++ bis E
E27, max. 46 W
D 120, L 1300
€ 95,00

6066042*
Titan / Silber
Glas Opal matt
EEK: A++ bis E
E27, max. 46 W
D 280, L 1200
€ 154,50

6509103*
Nickel matt
Glas Weiß
satinier
EEK: A++ bis E
E27, max. 57 W
H 1200, D 200
€ 111,60

2612136*
Nickel matt / schwarz,
Glas Alabaster Weiß
EEK: A++ bis E
E27, max. 77 W,
H 700-1500, D 400
Wendelzug
höhenverstellbar
€ 117,60

2623174*
Nickel matt
EEK: A++ bis E
E14, max. 25 W
H 140, B 300, A 95
€ 74,10



6870468*
Alu, Glas Opal
EEK: A++ bis E
E27, max. 77 W
D 300
€ 64,20



6870290*
Glas Opal
EEK: A++ bis E
E27, max. 77 W
D 300
€ 61,70



6870475*
Aluminiumfarbig
Glas alabaster-
farbig Weiß
EEK: A++ bis E
E27, max. 77 W
D 300
€ 69,10

6870291* Glas Opal
EEK: A++ bis E
E27, max. 46 W
D 200
€ 34,40



2623245.*
Stahl
EEK: A+
3 x 13 W, LED
3000 K, 1300 lm
H 355, D 600
stufenlos dimmbar
€ 297,30



2623170.*
Chrom,
Acrylglas
Weiß matt
EEK: A++ bis A
4 W, LED
3000 K, 2950 lm
H 160, D 500
dimmbar
€ 222,90

2623311.*
Nickel matt,
Schirm Chintz
hellgrau
EEK: A++ bis E
E27, max. 57 W
H 150, D 400
Stoff-
ummanteltes
Kabel hellgrau
€ 166,10



2623307.*
Chintz hellgrau,
Abdeckung
unten Weiß
EEK: A+
30 W, LED
3000 K, 3500 lm
H 100, D 400
dimmbar,
LED Module werkzeuglos
austauschbar
€ 319,80



2623312.*
Chintz hellgrau,
Abdeckung unten und oben weiß
EEK: A+
2 x G9 3,5 W, LED
3000 K, 700 lm
H 130, B 320, A 140
mit 10-Stufen-Dimmer,
LED Module austauschbar
€ 222,50



Einfaches Dimmen mit vorhandenem Schalter, kein externer Dimmer notwendig

2612271.*
Chrom / Alu,
Glas Weiß
satinier / klar
EEK: A+
4,5 W, LED
3000 K, 400 lm
H 130, B 150, T70
mit Schalter
€ 75,40



2622471.*
Nickel matt,
satinier
EEK: A+
2 x 5 W, LED
3000 K, 800 lm
H 200, L 170,
A 55
€ 81,00



3002433.* Weiß
EEK: A++ bis A
4 W, LED
3000 K, 240 lm
H 81, L 100
€ 192,70



2616161.*
Aluminium,
Diffusorlinse satiniert
EEK: A
16 W, LED
3000 K, 1400 lm
H 170, L 100,
A 170
€ 154,70



2622349.*
EEK: A+
4 x 8 W, LED
3000 K, 2900 lm
L 320, B 320, A 55
€ 190,10



Nickel satiniert, Glas teilsatiniert
dimmbar

2622338.*
EEK: A+
3 x 8 W, LED
3000 K, 2200 lm
D 320, A 55
€ 166,30



2622347*
Gläser Weiß mit
transparentem Rand
EEK: A++ bis E
E27, max. 46 W
L 300, B 300, A 90
€ 64,70



2622346*
Gläser Weiß
mit trans-
parentem Rand
EEK: A++ bis E
E27, max. 46 W
L 270, B 140, A 90
€ 48,70



2623169.*
Nickel matt,
Glas alabasterfarbig
EEK: A++ bis A
24,4 W / 4,3 W, LED
3000 K, 2785 lm /
3000 K, 503 lm
H 1820
dimmbar
€ 222,90



2622412.*
EEK: A+
5,3 W, LED
3000 K, 420 lm
A 120, D 90
€ 25,70

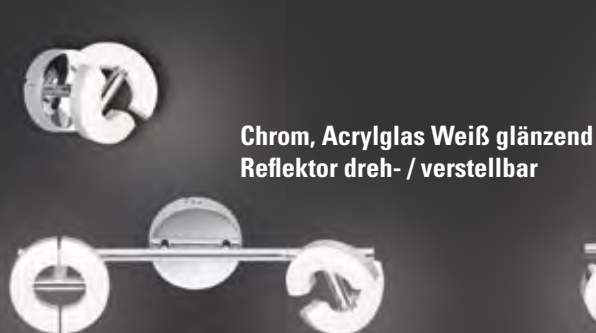

2622410.*
EEK: A+
5,3 W, LED
3000 K, 1260 lm
L 480, A 140
€ 72,60



2622409.*
EEK: A+
5,3 W, LED
3000 K, 840 lm
L 340, A 140
€ 51,80

6870276.*
EEK: A+
5,3 W, LED
3000 K, 1680 lm
L 760, A 140
€ 103,80



2623249.*
Stahl,
Opal matt Weiß,
Glasscheibe satiniert
EEK: A++
9 x 2 W G9, LED
3000 K, 6 x 180 lm
L 1610, A 60
€ 262,30

2616285.*
Nickel matt, Chrom,
Glas Weiß gewischt
EEK: A+
5 x 3,5 W G9, LED
3000 K, 300 lm
H 215, B 730, T 345
dimmbar
€ 152,60



6870640.* Nickel matt / Chrom
Glas alabasterfarbig Weiß
EEK: A++ bis E
4 x E14, max. 30 W
L 850 -1200, höhenverstellbar
Gesamtbreite B 850
Innenteil drehbar B 380
€ 205,50

2615125.* Stahl
EEK: A+
7 x 3 W, LED
3000 K, 7 x 250 lm
H 180, B 160, L 900
€ 189,40



2615121.*
Stahl
EEK: A+
9 x 3 W, LED, 3000 K, 9 x 250 lm
H 180, L 1300, B 160
€ 252,60



2623228.*
EEK: A+
Stahl
2 x 17 W, LED,
4 x 1,4 W, LED
3000 K, 1530 lm
H 1600, B 100, L 1100
stufenlos dimmbar
€ 356,80



2623190.*
EEK: A++ bis A
Aluminium matt
30 W, LED
2800 K, 2645 lm
H 2100, B 1200, T 30
dimmbar
€ 296,30



2623197.*
EEK: A++ bis A
Weiß matt / Aluminium
12 W, LED
3000 K, 920 lm
H 50, B 405, A 90
€ 165,40

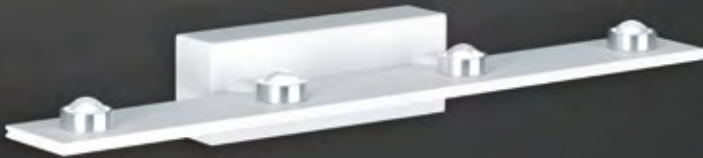

2623257.*
EEK: A+
2 x 2,5 W, LED / 5 W, LED
3000 K, 2 x 230 lm
L 255, H 200, B 130, A 200
inkl. Wippschalter
€ 74,20



Stahl, stufenlos dimmbar

2623240.*
EEK: A+
4 x 2,5 W, LED / 8 W, LED
3000 K, 4 x 230 lm
L 475, H 200, B 200, A 200
inkl. Wippschalter
€ 133,70



2623241.*
EEK: A+
8 x 2,5 W, LED /
2 x 11 W, LED
3000 K, 8 x 230 lm
L 1235, H 210, B 970
€ 297,30



2623242.*
EEK: A+
12 x 2,5 W, LED /
30 W, LED
3000 K, 12 x 230 lm
L 1880, H 230, B 1120,
A 230
€ 416,30



2622542.* Aluminiumfarbig
 EEK: A+
 3 x 15 W, LED
 3000 K, 3 x 1200 lm
 H 1200, B 110, A 1200
 4-stufig dimmbar
 € 395,30

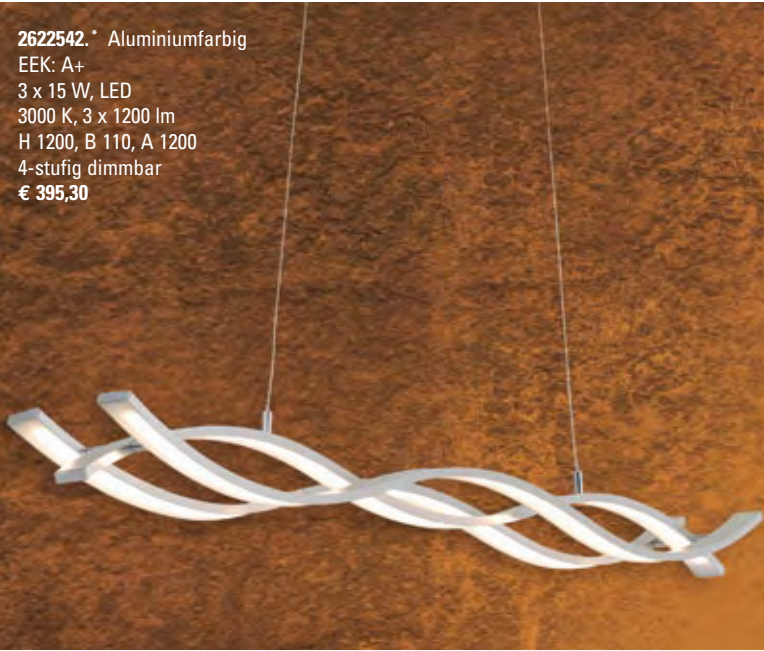

2622488.*
 3D-Folie Weiß,
 Abdeckung unten Weiß
 EEK: A+
 30 W, LED
 2700 K, 3500 lm
 H 100, D 400
 € 336,50



LED-Module werkzeuglos austauschbar,
 einfaches Dimmen mit vorhandenem Schalter,
 kein externer Dimmer notwendig

2622765*
 Nickel matt
 EEK: A++ bis E
 E27, max. 46 W
 H 257, B 285, D 160
 mit Schalter,
 inkl. Treiber,
 ohne Schirm
 € 282,00

Stoffschirm
 zu 2622765
2615414*
 Weiß
 Oval
 H 145, B 285, D 130
 € 53,50



2616275*
 Bronze
 EEK: A++ bis E
 E27, max. 46 W
 H 212, B 120, D 158
 mit Schalter,
 inkl. Treiber,
 ohne Schirm
 € 271,30

Stoffschirm
 zu 2616275
2615322*
 Schwarz
 Rund konisch
 H 145, D 215
 € 49,90



2623185*
 Keramik grau-braun
 dekoriert,
 Stoffschirm grau-braun
 EEK: A++ bis E
 E14, max. 30 W
 H 405, B 145, L 230
 mit Schnurschalter
 € 44,40



2622417*
 Holz Grau,
 Metall Schwarz,
 Schirm Struktur Grau
 EEK: A++ bis E
 E27, max. 46 W
 H 460, Schirm D 200
 € 57,00



2622414*
 Holz Grau, Metall Schwarz,
 Schirm Struktur Grau
 EEK: A++ bis E
 E27, max. 46 W
 H 1460, Schirm D 460
 € 155,90



2623120*
Stahl kupferfarben,
Textilkabel schwarz
EEK: A++ bis E
E27, 46 W
H 1100, D 310
€ 67,90



2623119*
Stahl schwarz, kupfer,
Textilkabel schwarz
EEK: A++ bis E
E27, 46 W
H 1100, D 310
€ 121,90



2623131*
Stahl schwarz, gold
EEK: A++ bis E
E27, 46 W
H 1500, D 380
€ 107,90

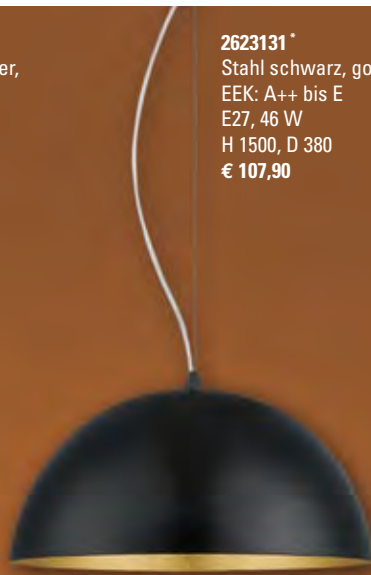

2615831*
Stahl
kupferfarben-antik,
Textilkabel schwarz
EEK: A++ bis E
E27, 46 W
H 1100, D 370
€ 73,90



2623122*
Stahl schwarz,
kupfer
EEK: A++ bis E
E27, 46 W
H 1355, B 600, T 600
mit Zugschalter
€ 107,90

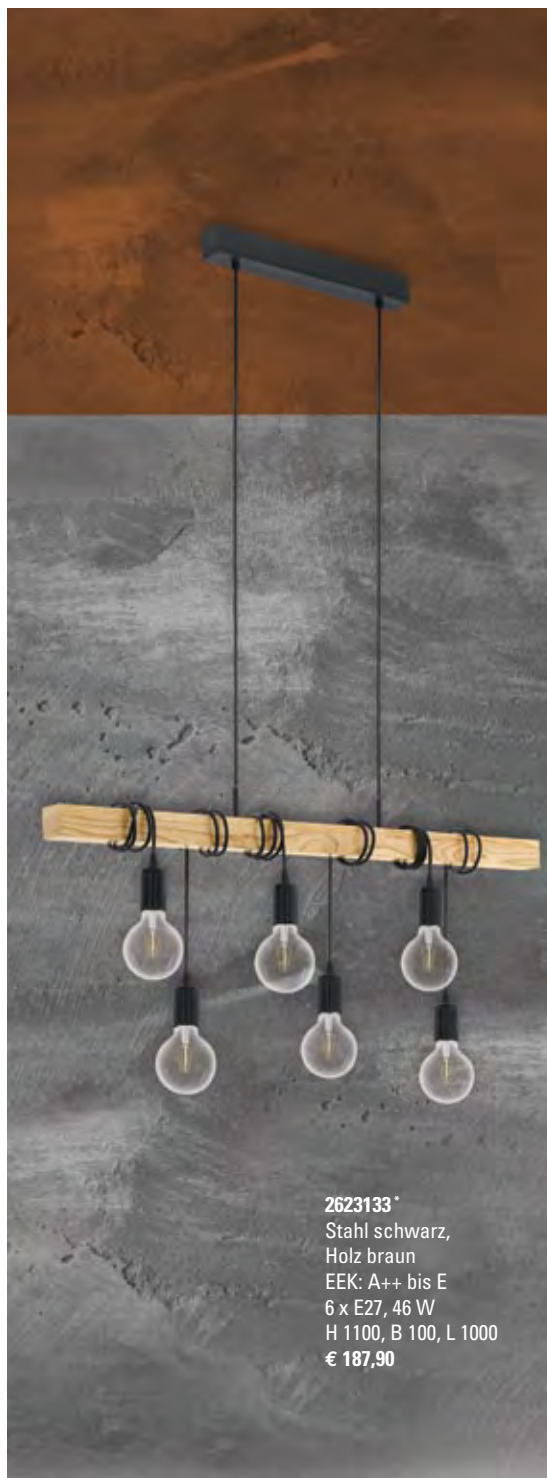

2623133*
Stahl schwarz,
Holz braun
EEK: A++ bis E
6 x E27, 46 W
H 1100, B 100, L 1000
€ 187,90



2505421*
LED-Filament-Lampe
Glas klar
EEK: A++
2400 K, 470 lm
E27, 4 W, LED
H 143, D 64
€ 17,80



2623121*
Stahl silber-antik,
Glas klar
EEK: A++ bis E
E27, 46 W
H 330, D 140
mit Kabelschalter
€ 60,90

o. Abb.
2615833*
Stahl schwarz
Glas klar
EEK: A++ bis E
€ 60,90



2604289*
Messing matt / poliert,
Glas Weiß
EEK: A++ bis E
5 x E14, max. 30 W
D 630, H 1300
€ 198,00



6870512*
Nickel matt,
Buche natur,
Glas alabasterfarbig
EEK: A++ bis E
E27, max. 77 W
D 400
€ 123,70

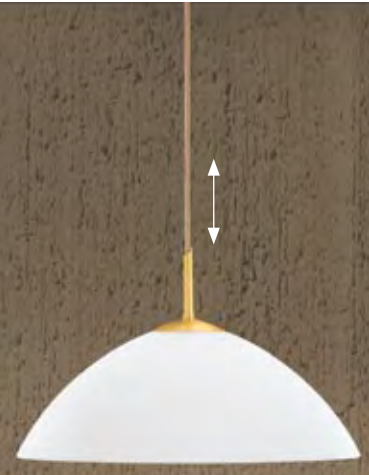

6509107*
Messing matt,
Glas Weiß satiniert
Kabellift höhenverstellbar
EEK: A++ bis E
E27, max. 57 W
H 700-1500, D 390
€ 151,10



2623171.* Messing matt, Acrylglas Weiß matt
EEK: A++ bis A, 4 W, LED, 3000 K, 2950 lm
H 160, D 500, dimmbar
€ 247,70



2612529*
Glas opal
glänzend /
antik Gold
EEK: A++ bis E
3 x E27, max. 57 W
H 110, D 450, A 110
€ 237,80



2623267.*
Goldfarbig / Glas satiniert
EEK: A+
12 W + 3,5 W, LED
3000 K, 1100 + 350 lm
H 60, D 320
€ 101,70

2616187.*
Messing matt,
Glas Weiß matt
mit Schalter
EEK: A+
4 W, LED
3000 K, 360 lm
H 60, B 90, L 200
€ 74,10



2612707*
Messing poliert,
Glas Alabaster Weiß
EEK: A++ bis E
2 x E27, max. 46 W
D 400
€ 57,60



2600378*
Messing poliert,
Glas Alabaster Weiß
EEK: A++ bis E
E27, max. 46 W
B 300, A 80
€ 30,30



2623262.*
Goldfarbig
EEK: A+
8 W, LED
3000 K, 800 lm
D 220, T 65
€ 50,80

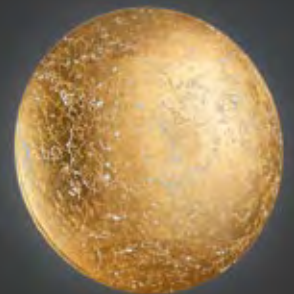

6598039*
Messing matt,
Glas Alabaster
Weiß
Wendelzug
höhenverstellbar
EEK: A++ bis E
E27, max. 77 W
H 700-1500, D 400
Zugpendel
€ 117,60

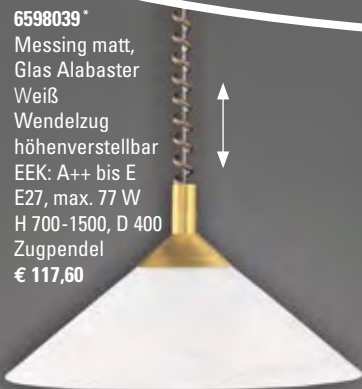

2603660*
Messing matt,
Glas alabasterfarbig Weiß
EEK: A++ bis E
3 x E27, max. 46 W
H 190, D 440
€ 136,10



2623172.*
Blattgoldfarbig
EEK: A++ bis A
22 W, LED
3000 K, 2050 lm
H 80, B 300, L 500
€ 148,50



Messing mit Glas alabasterfarben Weiß,
LED austauschbar

2616292.*
EEK: A+
6 W, LED, E14
3000 K, 470 lm
H 145, D 100, A 190
€ 32,90

2616293.*
EEK: A+
2 x 6 W, LED, E14
3000 K, 2 x 470 lm
H 190, B 330, T 100
€ 68,60

2616296.*
EEK: A+
6 x 6 W, LED, E14
3000 K, 6 x 470 lm
H 210, B 1800, T 110
€ 191,30

2616297.*
EEK: A+
3 x 6 W, LED, E14
3000 K, 3 x 470 lm
D 300
€ 101,70

2616294.*
EEK: A+
3 x 6 W, LED, E14
3000 K, 3 x 470 lm
H 190, B 550, T 100
€ 101,70

2616295.*
EEK: A+
4 x 6 W, LED, E14
3000 K, 4 x 470 lm
H 190, B 880, T 110
€ 127,20



2623179.*
Blattgoldfarbig
EEK: A++ bis A
16,8 W, LED
3000 K, 1570 lm
H 120, D 400
€ 247,70



2616269.*
Messing mit
Glas alabasterf. Weiß
EEK: A+
4 x 6 W, LED, E14
3000 K, 4 x 470 lm
LED austauschbar
H 950-1600
B 805, T 110
höhenverstellbar
€ 182,30



2623176.*
Messing poliert,
Alabasterfarbig Weiß
EEK: A++ bis A
24,4 W / 4,3 W, LED
3000 K, 2785 lm /
3000 K, 503 lm
H 1820, A 530
dimmbar
€ 222,90



2605787.*
Altmessing,
Glas alabasterfarbig Weiß, Dekor terra
EEK: A++ bis E, E27, max. 46 W
D 400
€ 49,30



2605819.*
Altmessing,
Glas alabasterfarbig Weiß,
Dekor terra
EEK: A++ bis E
E27, max. 77 W
D 400, L 1300
€ 66,60



6870616*
Rostfarbig / antik,
Glas alabasterfarbig champ
EEK: A++ bis E
3 x E27, max. 46 W
D 400
€ 123,70



6870647*
Rostfarbig / antik,
Glas champ dekoriert
EEK: A++ bis E
2 x E27, max. 30 W
D 400
€ 86,50

2602196*
Altmessing, Glas alabasterfarbig Weiß
EEK: A++ bis E
4 x E14, max. 30 W
L 850
höhenverstellbar
Innenteil drehbar, B 380
€ 205,50



2623177*
Rostfarbig / antik,
Schirm Leinen sandfarben
EEK: A++ bis E
E14, max. 30 W
H 1000-1400, L 850
höhenverstellbar
Mittelteil schwenkbar
€ 205,50

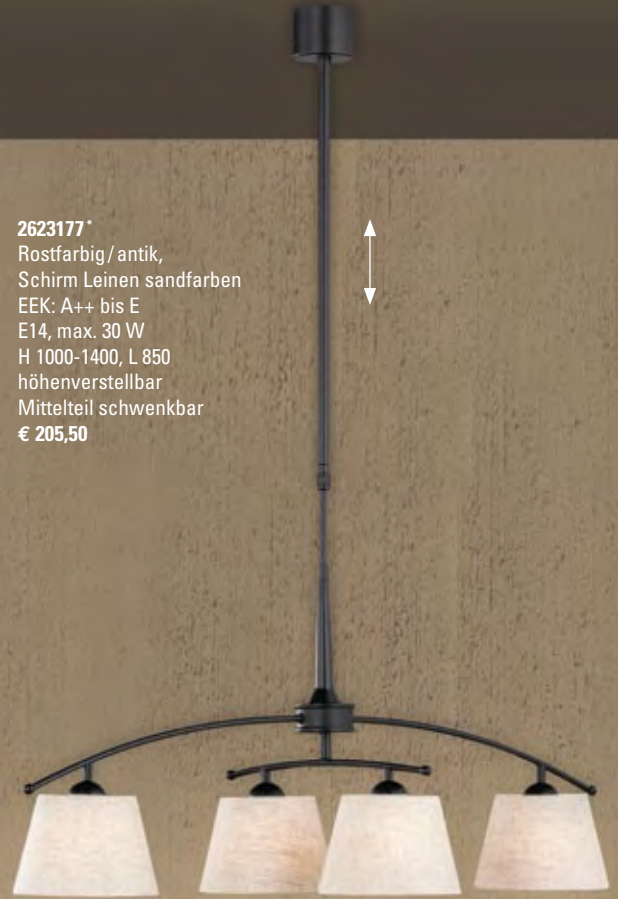

6870232*
EEK: A++ bis E
E27, max. 77 W
D 400
€ 98,90



2602228*
EEK: A++ bis E
2 x E27, max. 46 W
B 790, Glas D 330
€ 148,50



2601860*
EEK: A++ bis E
E27, max. 46 W
H 370, B 330, A 180
€ 74,10



Rostfarbig / antik,
Glas alabasterfarbig Weiß



2623168*
Rostfarbig / antik,
Schirm Leinen sandfarben
EEK: A++ bis E
E14, max. 30 W
H 330, L 850
Mittelteil schwenkbar
€ 198,10



6200257*
Braun-Gold
EEK: A++ bis E
E14, max. 46 W
H 480, B 180,
A 120
€ 74,30



2604239*
Rostfarbig,
Glas Weiß
EEK: A++ bis E
E14, max. 46 W
H 500, B 75, A 95
€ 74,40



2604285*
Rostfarbig antik
EEK: A++ bis E
5 x E14, max. 30 W
H 380, D 600
€ 180,70

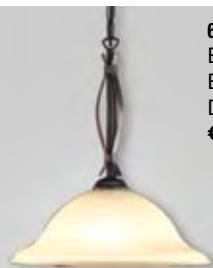

6870646*
EEK: A++ bis E
E27, max. 77 W
D 400
€ 111,30

**Rostfarbig / antik,
Glas champ. dekoriert**

6870648*
EEK: A++ bis E
E14, max. 30 W
A 130, B 240
€ 56,70



6870649*
EEK: A++ bis E
2 x E27, max. 46 W
B 750, Glas D 300
€ 136,10

6870611*
EEK: A++ bis E
E27, max. 77 W
D 400
€ 123,70

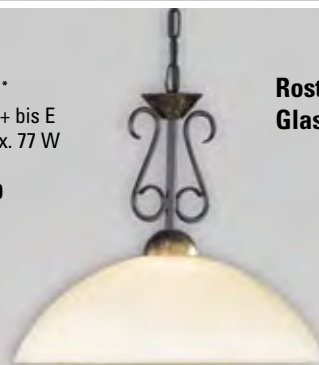

**Rostfarbig / antik,
Glas alabasterfarbig champ.**

6870610*
EEK: A++ bis E
E14, max. 30 W
H 220, B 240, A 120
€ 51,80

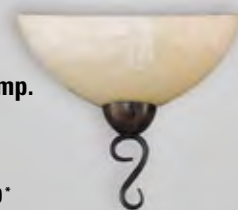

2612078*
Rostfarbig antik,
Glas Weiß
EEK: A++ bis E
2 x E27, max. 46 W
H 130, D 350
€ 74,10



2623266*
Glas alabasterfarbig
champagner
EEK: A++ bis E
3 x E27, max. 60 W
D 420, H 320
€ 132,00



2622416*
Keramik Weiß,
Dekor braun
EEK: A++ bis E
E14, max. 30 W
H 450, D 300
€ 51,80



2616143.*
EEK: A+
3,3 W, LED
3000 K, 340 lm
D 125
€ 37,50



2616144.*
EEK: A+
2 x 3,3 W, LED
3000 K, 680 lm
B 120, L 365
€ 69,30



2616145.*
EEK: A+
3 x 3,3 W, LED
3000 K, 1020 lm
B 120, L 565
€ 108,00



**Stahl Antik-Braun, Glas Weiß lackiert
LED tauschbar**

2616146.*
EEK: A+
4 x 3,3 W, LED
3000 K, 1360 lm
B 120, L 645
€ 133,80

Stahl, Alu, Alu-gebürstet



2623124.*
EEK: A+
5 W, GU10
3000 K, 400 lm
L 155, B 70
€ 34,90

2623125.*
EEK: A+
2 x 5 W, GU10
3000 K, 800 lm
L 250, B 70
€ 67,90

2623126.*
EEK: A+
3 x 5 W, GU10
3000 K, 1200 lm
L 380, B 70
€ 101,90

2623127.*
EEK: A+
4 x 5 W, GU10
3000 K, 1600 lm
L 270, B 270
€ 135,90

2623153.*
Aluminium gebürstet,
Diffusorlinsen satiniert
EEK: A+
4 x 8 W, LED
3000 K, 2800 lm
H max. 2000, B 900, T 80
Leuchtenkopf D 100, H 35
höhenverstellbar
dimmbar
€ 426,00



2623152.*
Nickel satiniert,
Glas satiniert
EEK: A+
12 W, LED
3000 K, 1200 lm
H 70, B 350, A 150
€ 197,50



2623154.*
Weiß,
Diffusorlinse satiniert
EEK: A+
2 x 8 W, LED
3000 K, 1400 lm
H 170, B 180, A 210
Up and Downlight
€ 188,00



Köpfe dreh- und schwenkbar,
4-Stufen-Dimmer durch wiederholtes Schalten



2616200.* Stahl
EEK: A
2 x 5,5 W, LED
3000 K, 2 x 350 lm
H 130, B 150, L 405
€ 59,30



2616202.* Stahl
EEK: A
4 x 5,5 W, LED
3000 K, 4 x 350 lm
H 125, B 130, L 790
€ 130,70

2616201.* Stahl
EEK: A
3 x 5,5 W, LED
3000 K, 3 x 350 lm
H 120, D 240
€ 95,00

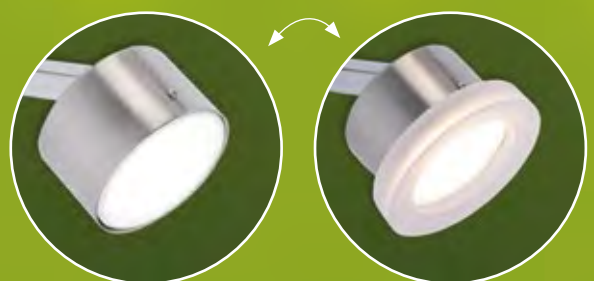



2623294.*
Nickel Matt, Glas mattiert
EEK: A+
3 x 3 W, GU10
3000 K, 3 x 250 lm
D 200, H 90
€ 68,90



2623292.*
Nickel Matt, Glas mattiert
EEK: A+
3 x 3 W, GU10
3000 K, 3 x 250 m
L 200, B 200, H 90
€ 68,90



2623293.*
Chrom, Glas mattiert
EEK: A+
4 x 3 W, GU10
3000K, 4 x 250 m
D 250, H 90
€ 98,70



2615173.*
4 W, LED
2700 K, 170 lm
H 82, B 118, T 60
€ 33,30

2615174.*
2 x 4 W, LED
2700 K, 330 lm
H 82, B 198, T 60
€ 66,60



Weiß
EEK: A++ bis A



2615175.*
3 x 4 W, LED
2700 K, 500 lm
H 82, D 198
€ 99,90



2622483.*
5 W, LED
3000 K, 419 lm
L 120, B 80, A 140
€ 44,40

2622481.*
2 x 5 W, LED
3000 K, 2 x 419 lm
H 140, L 280, B 80
€ 86,50



Chrom/Aluminium matt, Acrylglas satiniert
EEK: A++ bis A



2622477.*
3 x 5 W, LED
3000K, 3 x 419 lm
H 140, L 430, B 80
€ 123,70



2622479.*
4 x 5 W, LED
3000 K, 4 x 419 lm
H 180, L 650, B 80
€ 160,90

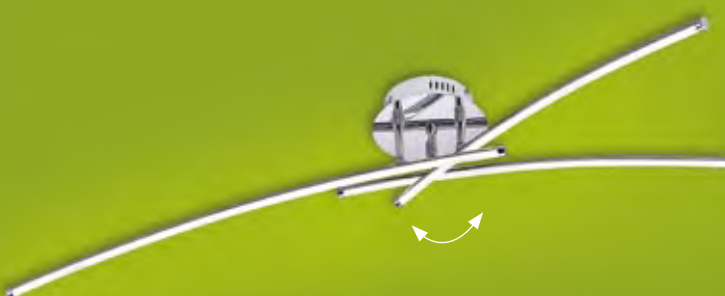

2623252.*
Chrom
EEK: A+
3 x 7,2 W, LED
3000 K, 650 lm
L 960, B 960, H 230,
A 230
Arme schwenkbar
€ 148,60



2623254.*
Chrom
EEK: A
3 x 10 W, LED
3000 K, 600 lm,
L 950, B 100, H 105,
A 105
€ 297,30





6502537*
EEK: A bis E
GU10, max. 50 W
H 130
mit Schalter
€ 25,70



6502538*
EEK: A bis E
2 x GU10, max. 50 W
L 310
mit 2 Schaltern
€ 51,40



6502536*
EEK: A bis E
4 x GU10, max. 50 W
L 700
€ 84,70

Nickel satiniert / Chrom

Silberfarben, Strahler dreh- und schwenkbar



2623287*
EEK: A+
3 W, GU10
3000 K, 250 lm
H 95, B 80, A 80
€ 17,10



2623288*
EEK: A+
2 x 3 W, GU10
3000 K, 2 x 250 lm
H 80, L 255, B 95
€ 32,90



2623290*
EEK: A+
4 x 3 W, GU10
3000 K, 4 x 250 lm
H 80, L 605, B 105
€ 72,40



2623289*
EEK: A+
3 x 3 W, GU10
3000 K, 3 x 250 lm
H 130, D 160
€ 52,70



2623291*
EEK: A+
6 x 3 W, GU10
3000 K, 6 x 250 lm
H 80, L 1204, B 120
€ 111,90

2605825*
Nickel matt
EEK: A+
LED 5 W, GU10
3000 K, 400 lm
A 110
mit Schalter
€ 48,00



2605872* Chrom
EEK: A+
LED 4 x 3 W, GU10
3000 K, 4 x 250 lm
L 695
€ 120,40



2605840*
Chrom
EEK: A+
LED 3 W, GU10
3000 K, 250 lm
A 110
mit Schalter
€ 33,80

2605831*
Nickel matt
EEK: A+
LED 2 x 5 W, GU10
3000 K, 2 x 400 lm
L 320
€ 93,60



2605863*
Chrom
EEK: A+
LED 2 x 3 W, GU10
3000 K, 2 x 250 lm
L 275
€ 65,60



2605868*
Chrom
EEK: A+
LED 3 x 3 W, GU10
3000 K, 3 x 250 lm
L 475
€ 95,20



2605821*
Nickel matt
EEK: A+
LED 4 x 5 W, GU10
3000 K, 4 x 400 lm
L 265, B 265
€ 160,50



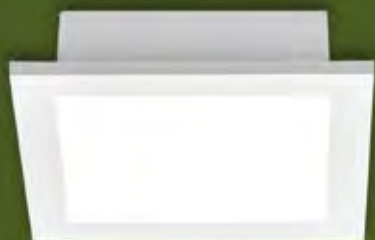

2622371.*
Weiß
EEK: A+
16 W, LED
4000 K, 1500 lm
H 60, L 200, B 200
€ 53,40



7802368.*
Aluminium
EEK: A++ bis A
29 W, LED
3000 K, 2020 lm
H 44, B 260, L 260
€ 208,20

o. Abb.
7802370.*
4000 K, 2130 lm
€ 208,20



7802371.*
Aluminium
EEK: A++ bis A
29 W, LED
3000 K, 2100 lm
H 44, D 270
€ 196,30

o. Abb.
7802372.*
4000 K, 2110 lm
€ 196,30

6574554.*
EEK: C
28 W, G9,
2800 K, 370 lm
A 150
mit Schalter
€ 19,40



Nickel matt, Glas Opal matt
Hochvolt-Halogen

6574557.*
EEK: C
28 W, G9,
2800 K, 370 lm
L 380
mit Flexarm
und Schalter
€ 22,70



6574552.*
Nickel matt, Glas Opal matt
Hochvolt-Halogen
EEK: C
3 x 28 W, G9, 2800 K, 3 x 370 lm
L 451
€ 49,00



6574555.*
Nickel matt
mit Schalter
Hochvolt-Halogen
EEK: C
2 x 28 W, G9,
2800 K, 2 x 370 lm
L 300
€ 38,70



2612005.*
EEK: A+
6 x 4,5 W, LED
3000 K, 6 x 400 lm
L max. 1500, 2 Gelenke
€ 297,20



2609403.*
EEK: A+
5 x 4,5 W, LED
3000 K, 5 x 400 lm
L 720, B 440
€ 270,00



2612006.*
EEK: A+
4 x 4,5 W, LED
3000 K, 4 x 400 lm
L max. 940
€ 218,00

Alu gebürstet,
Glas Weiß gewischt



2612007.*
EEK: A+
4 x 4,5 W, LED
3000 K, 4 x 400 lm
L 230, B 230
€ 232,00



2609406.*
EEK: A+
3 x 4,5 W, LED
3000 K, 3 x 400 lm
L 500
€ 163,50

2609405.*
EEK: A+
2 x 4,5 W, LED
3000 K, 2 x 400 lm
L 360
€ 129,40



2609404.*
EEK: A+
4,5 W, LED
3000 K, 400 lm
L 200
€ 68,00





2623273.*
EEK: A+
3 x 6 W, LED
3000 K, 3 x 550 lm
H 160, B 450, T 75
€ 101,70



2623274.*
EEK: A+
4 x 6 W, LED
3000 K, 4 x 550 lm
H 200, B 815, T 80
€ 127,20



2623275.*
EEK: A+
6 x 6 W, LED
3000 K, 6 x 550 lm
H 230, B 1770, T 100
€ 191,20

Nickel matt / Chrom

2622518.*
3 x 3 W, GU10 LED
3000 K, 3 x 250 lm
H 120, B 480, A 80
€ 80,60



2622517.*
2 x 3 W, GU10 LED
3000 K, 2 x 250 lm
H 120, B 275, A 80
€ 54,20



2622519.*
3 x 3 W, GU10 LED
3000 K, 3 x 250 lm
H 106, D 210
€ 80,60



Nickel matt
Strahler dreh- und schwenkbar
EEK: A+

2622516.*
3 W, GU10 LED
3000 K, 250 lm
H 90, D 80, A 106
€ 26,80

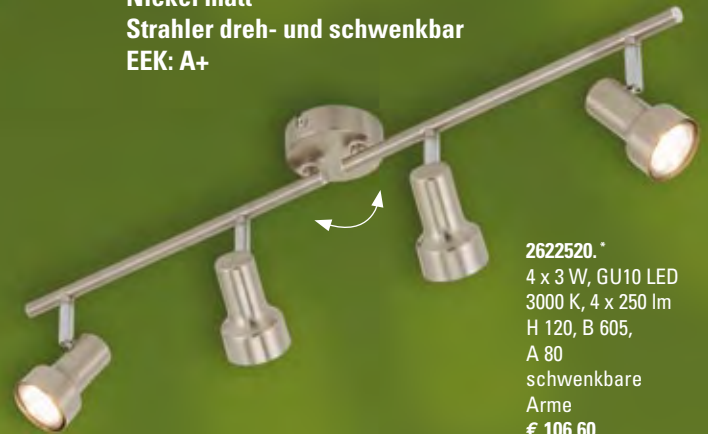

2622520.*
4 x 3 W, GU10 LED
3000 K, 4 x 250 lm
H 120, B 605,
A 80
schwenkbare
Arme
€ 106,60



2615102*
EEK: A+ bis E
Nickel matt
GU10, max. 35 W
A180
€ 29,50



2615100*
EEK: A+ bis E
Nickel matt
2 x GU10, max. 35 W
L 600, H 190
€ 74,10



2615094*
EEK: A+ bis E
Nickel matt
3 x GU10, max. 35 W
L 960, H 190
€ 111,30

Nickel matt, Glas Opal gewischt



2615095*
EEK: A+ bis E
Nickel matt
4 x GU10, max. 35 W
L 1082, H 190
€ 148,50

2623255.*
EEK: A+
5 x 5,5 W, LED
3000 K, 5 x 350 lm
H 100, B 460, L 460,
D 460
€ 272,50



Stahl, Köpfe schwenkbar,
4-Stufen-Dimmer durch wiederholtes Schalten



2623259.*
EEK: A+
4 W, LED
3000 K, 350 lm
H 100, B 130,
L 240
inkl. Kippschalter
€ 47,40



2616230.*
EEK: A+
2 x 5,5 W, LED
3000 K, 2 x 350 lm
H 100, B 150, L 390
€ 111,80

2616232.*
EEK: A+
4 x 5,5 W, LED
3000 K, 4 x 350 lm
H 100, B 200,
L 660
€ 213,00



2616231.*
EEK: A+
3 x 5,5 W, LED
3000 K, 3 x 350 lm
H 105, D 340
€ 163,60



2612897.*
Stahl
EEK: A+
5 x 6 W, LED Board
3000 K, 5 x 500 lm
L 2000
Einspeisung mit Flexarm
€ 416,30



2611881.*
EEK: C
30 W, E14
2800 K, 370 lm
D 80
Kippschalter
€ 17,60



2611880.*
EEK: C
2 x 30 W, E14
2800 K, 2 x 370 lm
L 385
€ 38,60



2611882.*
EEK: C
4 x 30 W, E14
2800 K, 4 x 370 lm
L 823
€ 70,50



2611884.*
EEK: C
6 x 30 W, E14
2800 K, 6 x 370 lm
L 1800
€ 105,90



Stahl,
Glas satiniert mit klarem Rand

2611879.*
EEK: C
3 x 30 W, E14
2800 K,
3 x 370 lm
D 275
€ 63,40





2623166.* Weiß / Chrom
EEK: A+
6 W, LED
3000 K, 480 lm
H 90, B 320, A 110
IP44
€ 118,70



2615051.* Weiß,
Diffusorlinse satiniert
EEK: A+
8 W, LED
3000 K, 700 lm
H 60, D250
€ 95,20



2615048.* Nickel satiniert,
Diffusorlinse satiniert
EEK: A+
48 W, LED, 3000 K, 4200 lm
H 70, B 500, L 1000
dimmbar
€ 521,20

1578436.*
Stahl / Chrom
EEK: A+
5 x 5 W, GU10 LED
3000 K, 5 x 400 lm
L 2000
€ 296,00



2623123.*
Alu, Stahl Alu, Chrom
EEK: A+
5 x 3 W, GU10
3000 K, 1200 lm
H 200, L 2000
€ 227,90

Stahl, RGB, inkl. IR-Fernbedienung

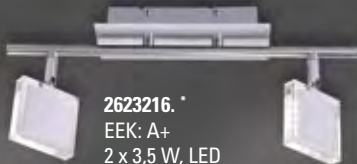

2623216.*
EEK: A+
2 x 3,5 W, LED
3000 K RGB,
2 x 300 lm
H 175, L 470, A 175
€ 59,30



2623217.*
EEK: A+
3 x 3,5 W, LED
3000 K RGB,
3 x 300 lm
H 175, L 715, A 175
€ 89,10



2623215.*
EEK: A+
3,5 W, LED
3000 K RGB, 300 lm
H 145, L 160, A 145
€ 35,50

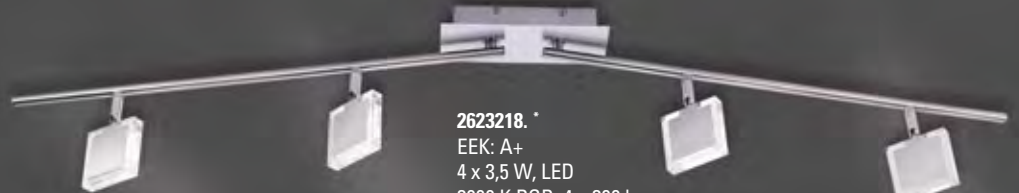

2623218.*
EEK: A+
4 x 3,5 W, LED
3000 K RGB, 4 x 300 lm
H 160, L 1280, A 160
€ 112,90

2623219.*
EEK: A+
6 x 3,5 W, LED
3000 K RGB, 6 x 300 lm
H 180, L 1920, A 180
€ 169,40



2623167.*
Metall Silbergrau
EEK: A+
8 W, LED
3000 K, 640 lm
H 500, B 130, A 80
€ 123,70



2613790.*
Stahl
EEK: A+
6 x 5 W, LED
3000 K, 6 x 480 lm
H 230, L 1610
dimmbar, schwenkbar
€ 318,30

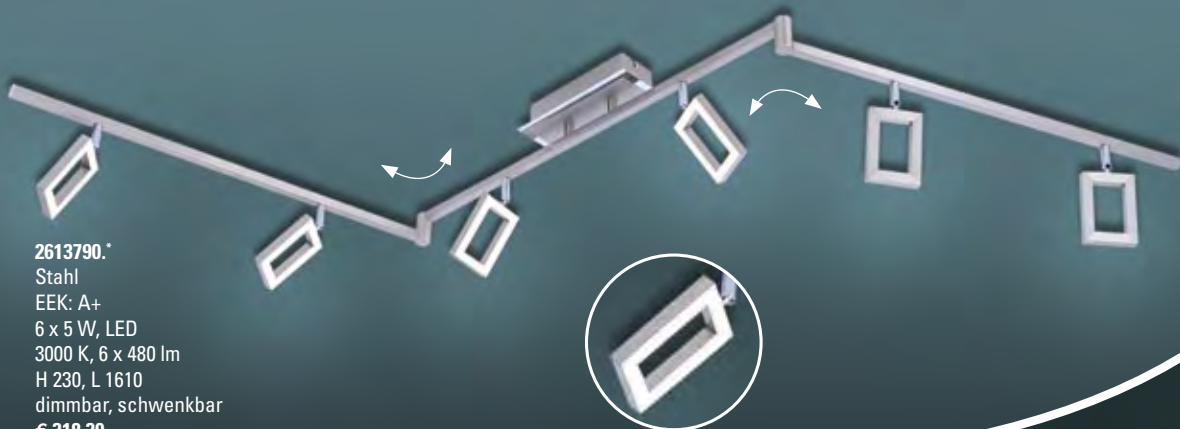

2616203.*
Stahl
EEK: A
6 x 5,5 W LED
3000 K, 6 x 350 lm
H 140, L 1910
€ 196,30

Köpfe dreh- und schwenkbar, Arme schwenkbar,
4-Stufen-Dimmer durch wiederholtes Schalten



2612683.*
Nickel satiniert / Chrom
EEK: C
6 x 50 W, GU10
L 1500
doppelt schwenkbar
€ 140,90

Stahl, Chrom /
Kunststoff, satiniert

2623135.*
EEK: A+
2 x 5,4 W, LED
K 3000, 1280 lm
L 360
€ 53,90

2623136.*
EEK: A+
3 x 5,4 W, LED
K 3000, 1920 lm
L 560
€ 80,90

2623134.*
EEK: A+
5,4 W, LED
K 3000, 640 lm
D 110
€ 26,90

2623137.*
EEK: A+
4 x 5,4 W, LED
K 3000, 2560 lm
L 760
€ 107,90

2623138.*
EEK: A+
6 x 5,4 W, LED
K 3000, 3840 lm
L 1595
€ 161,90



2623182.*

Nickel matt, Chrom,
Glas Weiß matt
EEK: A++ bis A
7 x 4,3 W, LED
2700-3350-4000K, 2900 lm
H 750-1500, L 1350
mit Dimmer an der Leuchte
€ 297,30

**2623220.***

Aluminium
EEK: A+
2 x 12 W, LED
3000 K, 2700 lm
H 1200, L 1495, B 50
stufenlos dimmbar
€ 148,60

**2623280***

EEK: A++ bis A
2 x max. 7 W, GU10
L 320, B 60, A 135
€ 106,90

**2623282***

EEK: A++ bis A
3 x max. 7 W, GU10
D 210, A 135
€ 154,50

2623281*

EEK: A++ bis A
3 x max. 7 W, GU10
L 540, B 60, A 135
€ 154,50

**2623279***

EEK: A++ bis A
max. 7 W, GU10
D 100, A 135
€ 67,70

**Struktur Weiß-Anthrazit /
Aluminium Druckguss**

**Reflektor dreh- /
schwenkbar**



Nickel satiniert / Chrom, Leuchtenkopf stufenlos schwenkbar – Kugelgelenk

**2623157.***

EEK: A+
8 W, LED
3000 K, 720 lm
H 100, D 75
€ 71,10

**2623158.***

EEK: A+
2 x 8 W, LED
3000 K, 1450 lm
H 100, B 200, T 70
€ 142,50

**2623159.***

EEK: A+
3 x 8 W, LED
3000 K, 2200 lm
H 100, B 320, T 70
€ 213,90

2622419.*
Nickel matt,
Glas teilsat., Rand klar
EEK: A+
5 x 5,5 W, LED
2700 K, 2200 lm
L 1130, H 960-1500
höhenverstellbar
dimmbar
€ 234,00

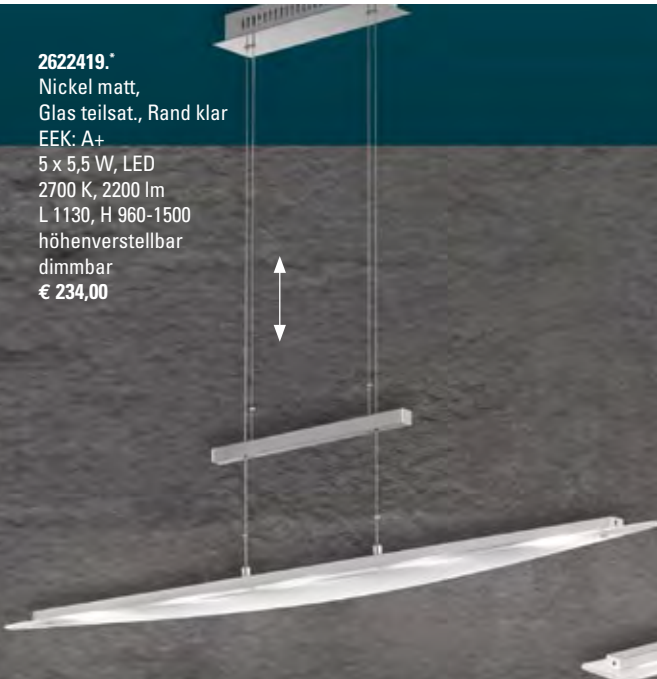

2616257.*
Nickel matt / Chrom,
Glas teilsat. / Rand klar
EEK: A++ bis A
4 x 4,8 W, LED
2700 K - 4600 K - 6500 K
einstellbar, 4 x 400 lm
H 800-1500, B 90, L 880
höhenverstellbar
dimmbar
€ 173,30



2616253.*
Nickel matt, Acrylscheibe
teilsat. / Rand klar
EEK: A++ bis A
5 x 4,8 W, LED
2700 K - 4600 K - 6500 K
einstellbar, 5 x 400 lm
H 800-1500, B 90, L 1050
höhenverstellbar
dimmbar
€ 297,30

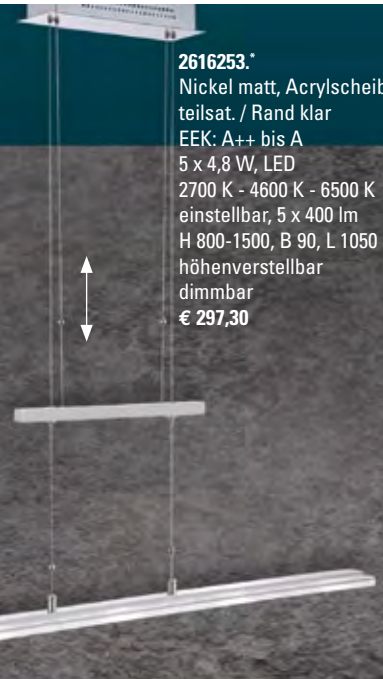

LED Seilsystem



2616291.*
chromfarbig
EEK: A++
5 x 3,8 W, LED
3100 K, 5 x 350 lm
B 5000, T 110,
D 170, A 157
€ 160,60

LED Seilsystem



2616289.*
chromfarbig
EEK: A++
5 x 3,8 W, LED
3000 K, 5 x 350 lm
B 5000, T 110,
D 170, A 170
€ 152,60

LED Seilsystem



2616288.*
titanfarbig
EEK: A+
5 x 3 W, MR16 LED
3000 K, 5 x 260 lm
B 5000, T 80, D 170, A 280
€ 114,80

LED Seilsystem



2622442.*
chromfarbig, Acryl Weiß
EEK: A+, 5 x 4,1 W, LED,
3000 K, 5 x 330 lm
H 150, B 5000, T 130
€ 165,80

2623142.*
Alu Nickel matt,
Kunststoff satiniert
EEK: A+
5,6 W, LED
3000 K, 680 lm
H 105, T 200, A 60
€ 80,90



2623143.*
Alu Nickel matt,
Kunststoff satiniert
EEK: A+
4,5 W, LED
3000 K, 480 K
D 130, A 50
€ 60,90



0644782.*
Nickel matt,
Acryl Weiß / klar
EEK: A++
2 x 3,2 W, LED
3000 K, 300 lm
H 165, D 60, A 100
mit Schalter
€ 102,80

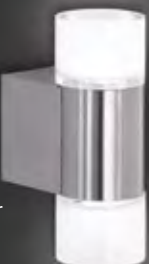

0644784.*
Nickel matt
EEK: A+, 8 W, LED
3000 K, 600 lm
H 105, B 485, A 100
€ 109,20



5804428.* Weiß
EEK: A+
25 W, LED
3000 K, 1850 lm
H 51, D 298
€ 149,90

o. Abb. **5804429.***
EEK: A+
4000 K, 2000 lm
€ 149,90

o. Abb. **5804438.***
EEK: A+
35 W, LED
3000 K, 2950 lm
H 67, D 400
€ 249,90

o. Abb. **5804439.***
EEK: A+
35 W, LED
4000 K, 3300 lm
H 67, D 400
€ 249,90

Erweiterungsleuchte für Leuchten mit Festanschluss oder für Leuchten mit Netzstecker für Lichtbandanordnungen (bis 15 m) ohne Dunkelstellen:

1405767.*	1405768.*
EEK: A++ bis A	EEK: A++ bis A
18 W, LED	18 W, LED
3000 K, 1800 lm	4000 K, 1850 lm
L 1180, B 25, H 44	L 1180, B 25, H 44
€ 148,70	€ 148,70

Silber

mit Netzstecker und Schalter:

1405761.*	1405762.*
EEK: A++ bis A	EEK: A++ bis A
10 W, LED	18 W, LED
3000 K, 930 lm	3000 K, 1800 lm
L 650, B 25, H 44	L 1220, B 25, H 44
€ 113,00	€ 148,70

mit Festanschluss:

1405763.*	1405764.*	1405765.*
EEK: A++ bis A	EEK: A++ bis A	EEK: A++ bis A
10 W, LED	10 W, LED	18 W, LED
3000 K, 930 lm	4000 K, 980 lm	3000 K, 1800 lm
L 580, B 25, H 44	L 580, B 25, H 44	L 1180, B 25, H 44
€ 113,00	€ 113,00	€ 148,70
		1405766.*
		EEK: A++ bis A
		18 W, LED
		4000 K, 1850 lm
		L 1180, B 25, H 44
		€ 148,70

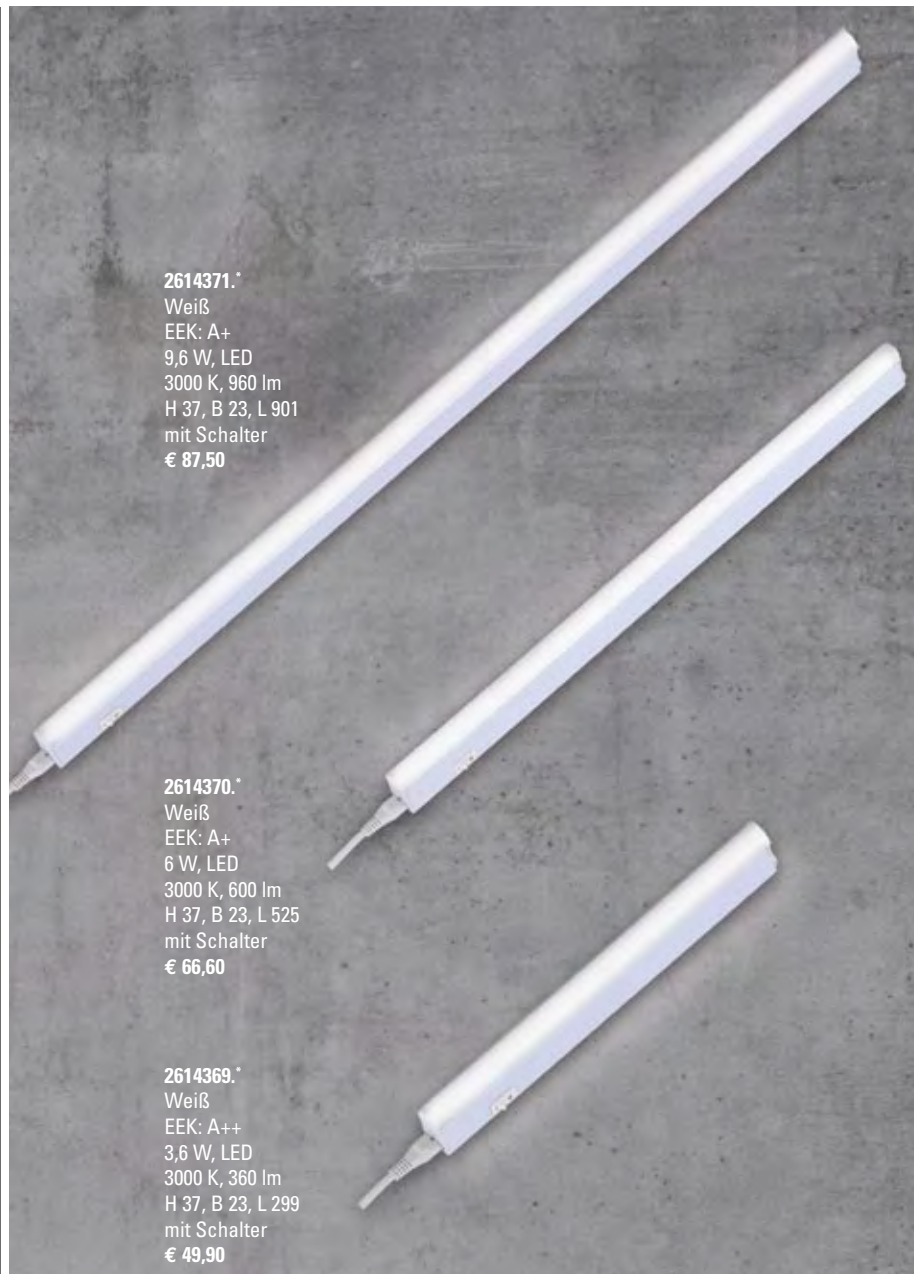

2614371.*
Weiß
EEK: A+
9,6 W, LED
3000 K, 960 lm
H 37, B 23, L 901
mit Schalter
€ 87,50

2614370.*
Weiß
EEK: A+
6 W, LED
3000 K, 600 lm
H 37, B 23, L 525
mit Schalter
€ 66,60

2614369.*
Weiß
EEK: A++
3,6 W, LED
3000 K, 360 lm
H 37, B 23, L 299
mit Schalter
€ 49,90

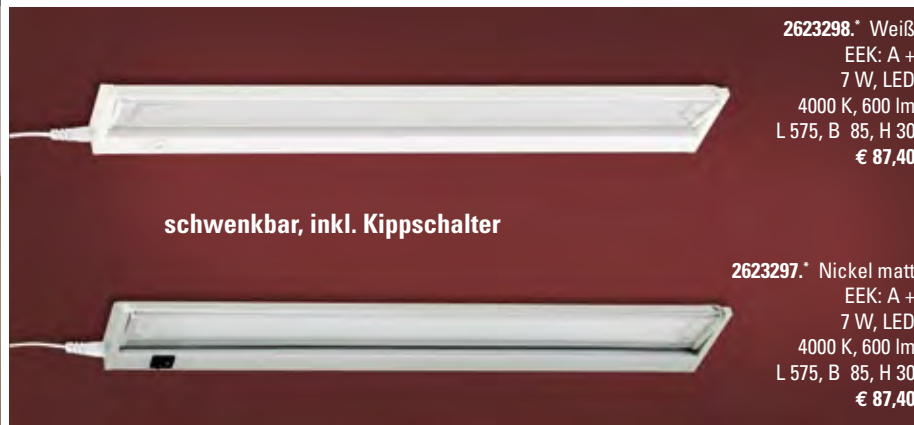

2623298.* Weiß
EEK: A+
7 W, LED
4000 K, 600 lm
L 575, B 85, H 30
€ 87,40

schwenkbar, inkl. Kippschalter

2623297.* Nickel matt
EEK: A+
7 W, LED
4000 K, 600 lm
L 575, B 85, H 30
€ 87,40

2622613.* Weiß
EEK: A+
35 W, LED
3000 K, 3325 lm
L 1197, B 80, H 40
IP20
€ 107,00



o. Abb.
2622614.*
EEK: A+
35 W, LED
4000 K, 3500 lm
€ 107,00

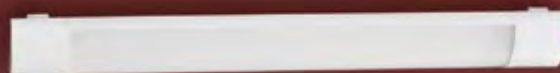

2622629.* Weiß
EEK: A+
20 W, LED
3000 K, 1805 lm
L 597, B 80, H 40
IP 20
€ 59,40

o. Abb.
2622630.*
EEK: A+
20 W, LED
4000 K, 1900 lm
€ 59,40



0644816.*
 Chrom,
 Kunststoff Weiß
 EEK: A, 12 W, LED
 3000 K, 700 lm
 H 80, D 310
 € 68,30

o. Abb.
0644817.* EEK: A
 23 W, LED
 3000 K, 1400 lm
 H 80, D 420
 € 136,70



2616129.*
 Chrom,
 Glas Weiß
 EEK: A+, 20 W, LED
 3000 K, 2000 lm
 H 105, D 420
 € 169,10



2622396.*
 Weiß
 EEK: A+
 14 W, LED
 3000 K, 1200 lm
 D 300, H 65
 € 167,70



2616179.*
 Acryl Weiß, aluminiumfarbig matt
 EEK: A+, 17 W, LED, 3000 K, 1600 lm
 D 350, A 60
 € 106,30



2612109 *
 Titan / Silber / Glas Opal matt
 EEK: A++ bis E
 2 x E27, max. 46 W
 D 360, A 90
 € 142,60



2612712 *
 Messing poliert,
 Glas Alabaster Weiß
 EEK: A++ bis E
 3 x E27, max. 46 W
 D 500
 € 88,60

2612709 *
 Messing poliert,
 Glas Alabaster
 EEK: A++ bis E
 E27, max. 46 W
 D 300
 € 38,40

o. Abb.
2612714 *
 Nickel matt,
 Glas Alabaster Weiß
 EEK: A++ bis E
 3 x E27, max. 46 W
 D 500
 € 88,60

o. Abb.
2612711 *
 Nickel matt,
 Glas Alabaster
 EEK: A++ bis E
 E27, max. 46 W
 D 300
 € 38,40

Mit integriertem HF-Bewegungsmelder



1567577.* Opalglas, Weiß matt
 EEK: A+
 9 W, LED, 3000 K, 550 lm
 D 300, H 106
 € 113,00

o. Abb. **1597548.***
 EEK: A+
 14 W, LED, 3000 K, 1150 lm
 D 370, H 118
 € 172,50



1543893 * Weiß
 EEK: E
 E27, max. 46 W
 D 370, H 118
 € 187,40



2611754.* Edelstahl
 EEK: A
 12 W, LED
 3500 K, 840 lm
 H 45, B 300, T 300
 € 164,20

o. Abb.
2611755.*
 EEK: A
 17 W, LED
 3500 K, 1200 lm
 H 45, B 400, T 400
 € 260,30



2623269.*
 Acryl Weiß / Rand Chrom
 EEK: A
 24 W, LED, 3000 K, 2100 lm
 D 410, H 100
 dimmbar
 € 114,70



2616204.* Stahl, Acrylglas,
 IP 44 spritzwassergeschützt
 EEK: A, 12 W, LED
 3000 K, 700 lm
 H 85, L 335, B 335
 € 49,70

o. Abb.
2616205.* EEK: A+
 20 W, LED
 3000 K, 1900 lm
 H 95, L 430, B 430
 € 73,10



1538493 *
 Nickel matt
 EEK: A+, A, C, E
 E27, max. 46 W
 L 310, B 310, H 95
 € 108,00



2623268.*
 Weiß, Rand klar
 EEK: A+
 21 W, LED, 4000 K, 2200 lm
 D 420, H 95
 Starlight-Cover, mit Switch-Dimmer
 € 76,30



0644822.*
Acryl Weiß
EEK: A
50 W, LED
3000 - 5500 K, max. 4000 lm
D 600
€ 252,50

Lichtfarbe 3000-5500 K einstellbar
inklusive Fernbedienung
dimmbar
Nachtlicht schaltbar

2623270.*
Weiß
EEK: A+
80 W, LED
3000-5500 K, max. 6400 lm
H 108, D 800
mit Fernbedienung, dimmbar, mit Farbwechsel, Starlight-Effect
€ 254,70

2623271.*
Chrom
EEK: A+
100 W, LED
3000-6000 K, max. 9000 lm
H 100, D 670
mit Fernbedienung,
dimmbar, mit Nachtlicht
€ 328,90

o. Abb.
2623272.*
EEK: A+
30 W, LED, 3000-6000 K
max. 3100 lm
H 70, D 420
€ 140,20



2616234.*
Stahl gebürstet
EEK: A
2 GX13, max. 40 W
2700 K, 2350 lm
B 368, H 68
€ 105,90



2616184.*
Chrom,
Acrylglas Weiß
EEK: A+
17,5 W, LED, 3000 K, 1800 lm
D 450, A 50
€ 111,30

0644823.*
Aluminium gebürstet /
Acryl Weiß
EEK: A
30 W, LED, 3000 K, 3000 lm
B 815, T 315
dimmbar
€ 271,40



2620893.*
Grau
EEK: A++ bis A
12 W, LED
2700 K, 1200 lm
H 66, D 290
€ 49,90

o. Abb.
2620892.*
Weiß
EEK: A++ bis A
€ 49,90

Bajonettverschluss,
LED-Module sind
werkzeuglos austausch-
bar. Einfaches Dimmen
mit vorhandenem
Schalter, kein externer
Dimmer notwendig.

2623308.*
Opalglas Weiß matt
EEK: A+
13 W, LED
3000 K, 1300 lm
H 120, D 300
€ 118,40



o. Abb.
2623309.* EEK: A+
20 W, LED
3000 K, 1800 lm
H 140, D 360
€ 147,50



o. Abb.
2623310.* EEK: A+
24 W, LED
3000 K, 2400 lm
H 150, D 450
€ 234,30

3702778.*
Weiß
EEK: A+
14 W, LED
3000 K, 1150 lm
D 360, H 100
€ 176,10

2622492.*
Nickel matt,
Glas Weiß satiniert
EEK: A+
20 W, LED
2700 K, 2150 lm
D 300
€ 133,20



o. Abb.
2622494.*
EEK: A+
24 W, LED
2700 K, 3250 lm
D 400
€ 198,20

LED-Module werkzeuglos austauschbar.
Einfaches Dimmen mit vorhandenem Schalter,
kein externer Dimmer notwendig.



2622491.*
Gold matt,
Glas Weiß satiniert
EEK: A+
20 W, LED
2700 K, 2150 lm
D 300
€ 133,20

o. Abb.
2622493.*
EEK: A+
24 W, LED
2700 K, 3250 lm
D 400
€ 198,20



Mit Bewegungsmelder 100°

2603503.* Silber
EEK: A++ bis E
E27, max. 46 W
D 300
IP 44
€ 76,80

o. Abb.
2604238.*
Weiß
EEK: A++ bis E
€ 76,80

2600650.*
Nickel satiniert,
Glas Weiß
EEK: A++ bis E
2 x E27, max. 46 W
H 130, D 400
€ 53,70

o. Abb.
2600651.* EEK: A++ bis E
E27, max. 46 W
H 95, D 300
€ 36,10



6502539.*
Nickel satiniert,
Glas Weiß
EEK: A++ bis E
E27, max. 46 W
H 95, L 300
€ 31,60



2605834.*
Stahl,
Glas Opal matt
EEK: A++ bis E
2 x E14, max. 30 W
L 230, B 230
€ 40,80



2605743.*
Nickel satiniert,
Glas Weiß mit Dekor
EEK: A++ bis E
E27, max. 46 W
H 95, D 300
€ 36,80



2601233.*
Opalglas
Weiß matt
EEK: A++ bis E
E14, max. 30 W
H 240, B 130, A 80
€ 31,90



2600487.*
Nickel matt, Glas Weiß matt
EEK: A++ bis E
E27, max. 46 W
L 400, B 400
€ 49,30



2612088.*
Chrom, Glas Weiß
mit Dekor
EEK: A++ bis E
E27, max. 46 W
L 300, B 300
€ 39,40



2612796.*
Chrom, Glas
satiniert / Rand klar
EEK: A+
max. 12 W, LED
3000 K, 960 lm
L 360, B 360
€ 235,20



2615033.*
Weiß /
Abdeckung Kunststoff
EEK: A++ bis A
14 W, LED, 3000 K, 1120 lm
D 360, A 100
€ 77,20



o. Abb.
2622454.*
EEK: A++ bis A
10 W, LED
3000 K, 800 lm
D 300, A 100
€ 65,30

o. Abb.
2622466.*
EEK: A++ bis A
14 W, LED
4000 K, 1120 lm
D 360, A 100
€ 77,20



1594357.* Weiß
EEK: A++
14 W, LED
4000 K, 1450 lm
D 360, H 100
€ 213,00

6598054.* Nickel matt,
Glas Weiß satiniert
EEK: A++ bis E,
E27, max. 46 W
D 300
€ 53,30



Spotköpfe dreh- und schwenkbar



2622513.*
Chrom
EEK: A+
4,5 W, LED, 3000 K, 400 lm
B 115, H 75, A 140
inkl. Zugschalter
€ 52,70



2622514.*
Chrom
EEK: A+
2 x 4,5 W, LED
3000 K, 2 x 400 lm
B 325, H 170, A 80
€ 105,40



2622515.*
Chrom
EEK: A+
3 x 4,5 W, LED
3000 K, 3 x 400 lm
D 250, A 145
€ 170,10



2614362.*
Chrom
EEK: A+
3 x 3 W, LED GU10,
3000 K, 3 x 250 lm
D 160
€ 93,60

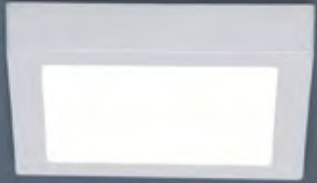

2616116.* Weiß /
Abdeckung Kunststoff
EEK: A++ bis A, 18 W, LED
3000 K, 1450 lm
L 225, B 225, A 40
€ 106,90



2616115.* Weiß /
Abdeckung Kunststoff
EEK: A++ bis A, 18 W, LED
3000 K, 1450 lm
D 240, A 40
€ 106,90

o. Abb.
2622461.*
EEK: A++ bis A
12 W, LED
3000 K, 950 lm
L 170, B 170, A 40
€ 71,20

o. Abb.
2622460.*
EEK: A++ bis A
6 W, LED
3000 K, 400 lm
L 120, B 120, A 40
€ 53,40

o. Abb.
2622459.*
EEK: A++ bis A
12 W, LED
3000 K, 950 lm
D 180, A 40
€ 71,20

o. Abb.
2622458.*
EEK: A++ bis A
6 W, LED
3000 K, 400 lm
D 120, A 40
€ 53,40



2616265.*
Chrom
EEK: A++ bis E
E27, max. 46 W
D 250, H 100
€ 40,90

o. Abb.
2616268.*
D300, H 100
€ 61,40



2616264.*
Nickel matt,
Glas Weiß satiniert
EEK: A++ bis E
E27, max. 46 W
D 250, H 100
€ 40,90

o. Abb.
2616267.*
D 300, H 100
€ 61,40

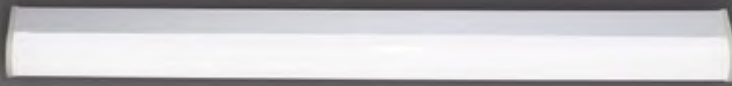

2616113.*
Weiß, Abdeckung Kunststoff
EEK: A+
12 W LED, 3000 K, 950 lm
H 600, B 55, A 100
€ 118,80

o. Abb.
2616114.*
EEK: A+
18 W LED, 3000 K, 1450 lm
H 900, B 55, A 100
€ 142,60

6598060.*
Chrom, Glas Weiß satiniert
EEK: A++ bis E
4 x E14, max. 30 W
H 100, L 590, A 80
€ 118,40

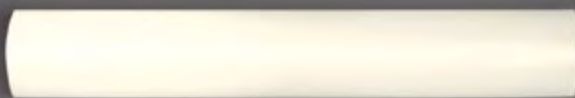

1539001.*
Weiß
EEK: A+ bis B
G5, 14 W
H 87, B 55, L 600
€ 152,90



1578447.*
Kunststoff
EEK: A+
4 W, LED
3000 K, 350 lm
H 37, B 23, L275
€ 38,00

1578448.*
Kunststoff
EEK: A+
4 W, LED
4000 K, 380 lm
H 37, B 23, L275
€ 38,00

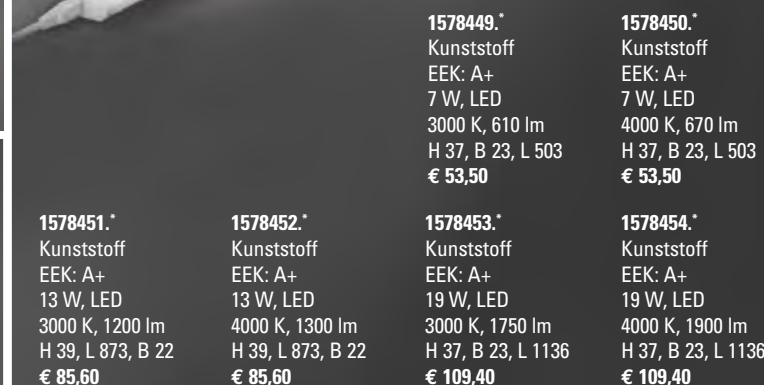

1578449.*
Kunststoff
EEK: A+
7 W, LED
3000 K, 610 lm
H 37, B 23, L 503
€ 53,50

1578450.*
Kunststoff
EEK: A+
7 W, LED
4000 K, 670 lm
H 37, B 23, L 503
€ 53,50

1578451.*
Kunststoff
EEK: A+
13 W, LED
3000 K, 1200 lm
H 39, L 873, B 22
€ 85,60

1578452.*
Kunststoff
EEK: A+
13 W, LED
4000 K, 1300 lm
H 39, L 873, B 22
€ 85,60

1578453.*
Kunststoff
EEK: A+
19 W, LED
3000 K, 1750 lm
H 37, B 23, L 1136
€ 109,40

1578454.*
Kunststoff
EEK: A+
19 W, LED
4000 K, 1900 lm
H 37, B 23, L 1136
€ 109,40



2612852.*
Silber
EEK: A++ bis A
20 W, LED
3000 K, 1000 lm
H 70, D 298
€ 123,70

o. Abb.
2612851.*
mit Sensor
€ 160,60



2623286.*
Chrom
EEK: A+
9 W, LED
3000 K, 800 lm
H 103, D 345
€ 105,30



2615378*
Chrom poliert
EEK: A bis E
E 27, max. 46 W Eco
D 170, A 170
€ 119,00

3-Stufen (3000 / 4000 / 5000 K)
durch wiederholtes Schalten



2623227.*
Weiß
EEK: A+
17 W, LED
3000-5000 K, 1530 lm
H 95, D 350
Sternenhimmeloptik
€ 53,40

3-Stufen (3000 / 4000 / 6000 K)
durch wiederholtes Schalten



2623226.*
Weiß
EEK: A+
12 W, LED
3000-6000 K, 900 lm
H 100, D 380
Sternenhimmeloptik
€ 80,20



2604378*
Weiß
Glas Weiß mattiert
EEK: A++ bis E
E27, max. 46 Watt
H 90, D 270
€ 40,10

o. Abb.
2604379*
Chrom
EEK: A++ bis E
€ 43,90



2604229*
Chrom,
Glas Opal matt Weiß
EEK: A++ bis E
E27, max. 46 W
H 80, D 320, IP 44
€ 44,10

o. Abb.
2604230*
Nickel matt
EEK: A++ bis E
E27, max. 46 W
H 80, D 310, IP 44
€ 44,10

o. Abb.
2622440*
Weiß
EEK: A++ bis E
E27, max. 46 W
H 80, D 310, IP 44
€ 44,10



2623300.*
Chrom poliert
EEK: A
16 W (32 x 0,5 W), LED
2700 K, 771 lm
H 87, D 300
€ 223,70



6020337*
Glas Alabaster
Weiß
EEK: A++ bis E
2 x E27, max. 46 W
D 360, A 120
€ 96,20



6020228*
Chrom / Glas
Alabaster Weiß
EEK: A++ bis E
E14, max. 30 W
H 200, D 80, A 150
€ 77,20

2623196.* Chrom
EEK: A++ bis A
15 W, LED
2700-6000 K, 1290 lm
H 40, B 990, A 110
dimmbar, inkl. Fernbedienung
€ 272,50



2623195.*
EEK: A++ bis A
12 W, LED
2700-6000 K, 1020 lm
H 40, B 790, A 110
€ 236,80

o. Abb.
2623194.*
EEK: A++ bis A
8 W, LED
2700-6000 K, 680 lm
H 40, B 490, A 110
€ 201,10



2615190.*
Chrom
EEK: A
3,2 W LED,
3000 K, 165 lm
L 350, T 180
€ 301,00

o. Abb.
2615191.*
EEK: A
7,2 W LED,
3000 K, 387 lm
L 620, T 180
€ 417,60

2616029.*
Chrom
EEK: A
5,7 W, LED
2700 K, 93 lm
D 214, B 270 mm
Schalter,
inkl. Treiber
€ 386,70



Spiegelaufbauleuchte



2623283.*
Chrom
EEK: A+
5,5 W, LED
3000 K, 550 lm
H 63, L 400, A 185
€ 79,00

Spiegelaufbauleuchte



2623284.*
Chrom
EEK: A+
10 W, LED
3000 K, 1000 lm
L 600, A 102
€ 133,00



6100011.*
Chrom
EEK: A++
2 x 2,5 W, LED G9
3000 K, 2 x 210 lm
H 70, L 255, A 75
€ 79,00



2615338.*
Chrom
EEK: A
3,6 W, LED
3000 K, 293 lm
D 40, B 340
€ 295,10



2623285.*
Chrom
EEK: A++
2 x 2,5 W, LED G9
3000 K, 2 x 210 lm
L 230, A 260
€ 85,50



2605800.*
Chrom, Glas Weiß
EEK: C
33 W, G9
L 250, A 140
€ 74,10

2615368*
 Chrom
 EEK: A+ bis A
 T5, 24 W
 H 60, B 40, L 600,
 inkl. EVG
 € 240,30



o. Abb. **2615369***
 EEK: A+ bis A
 T5, 39 W, L 900
 € 340,30

2604301.*
 Chrom / Acryl
 EEK: A
 14 W, T5, Schutzart IP 44
 L 690, A 80
 € 185,60



inkl. Endkappen in Chrom



2622511.*
 Chrom
 EEK: A+
 6 W, LED,
 3000 K, 500 lm
 B 370, H 65, A 80
 € 98,10



2622512.*
 Chrom
 EEK: A+
 6 W, LED, 3000 K, 500 lm
 B 370, H 50, A 268
 schwenkbar, inkl. Kippschalter
 € 130,30

2615386*
 Chrom
 EEK: A bis C
 T5, 24 W
 H 40, T 80, L 600
 inkl. EVG
 € 307,00



o. Abb. **2615387***
 EEK: A bis C
 T5, 39 W, L 900
 € 422,40

6020218*
 Chrom /
 Glas Opal matt
 EEK: A++ bis E
 2 x E14,
 max. 30 W
 H 450, D 80
 € 160,50



6020214*
 Chrom /
 Glas Opal matt
 EEK: A++ bis E
 E14, max. 30 W
 H 250, D 80
 € 136,70



2623192.*
 Chrom,
 Acrylglas satiniert
 EEK: A++ bis A
 18 W, LED
 2900 K, 1560 lm
 H 40, B 900, A 60
 € 189,20

o. Abb. **2623191.***
 EEK: A++ bis A
 12 W, LED
 2900 K, 1040 lm
 H 40, B 600, A 60
 € 141,60

o. Abb. **2623193.***
 EEK: A++ bis A
 24 W, LED
 2900 K, 2080 lm
 H 40, B 1200, A 60
 € 236,80

2622750.*
 Chrom poliert
 EEK: A
 12,2 W, LED
 3000 K, 810 lm
 H 33, B 900, A 60
 € 464,10



o. Abb. **2622749.***
 EEK: A
 7,9 W, LED
 3000 K, 535 lm
 H 33, B 600, A 60
 € 330,80

2622752.*
 Chrom poliert
 EEK: A
 12,2 W, LED
 3000 K, 836 lm
 H 33, B 900, A 60
 € 464,10



o. Abb. **2622751.***
 EEK: A
 7,9 W, LED
 3000 K, 475 lm
 H 33, B 600, A 60
 € 330,80



LED Platine austauschbar Glas satiniert

2612692.*

Verchromt

EEK: A

28 W, LED

3000 K, 2450 lm

H 120, L 400, B 400

€ 185,60

o. Abb.

2615040.*

Weiß

€ 173,70

o. Abb.

2615041.*

Nickel satiniert

€ 185,60

o. Abb.

2615039.*

Nickel satiniert

EEK: A+,

15 W, LED

3000 K, 1400 lm

H 85, L 300, B 300

€ 154,70

o. Abb.

2615037.*

Weiß

EEK: A+

15 W, LED

3000 K, 1400 lm

H 85, L 300, B 300

€ 141,60

o. Abb.

2615038.*

Verchromt

EEK: A+

15 W, LED

3000 K, 1400 lm

H 85, L 300, B 300

€ 154,70



2622372.*

Weiß

EEK: A

20 W, LED

4000 K, 1750 lm

L 300, B 300,

H 56

€ 89,10

o. Abb.

2622373.*

EEK: A

28 W, LED

4000 K, 2400 lm

L 450, B 450

H 56

€ 118,80

o. Abb.

2622374.*

EEK: A

41 W, LED

4000 K, 3600 lm

L 620, B 620

H 56

€ 178,30

6502541*

Nickel satiniert,
Glas Weiß mit Dekor

EEK: A++ bis E

E27, max. 46 W

H 95, D 300

€ 36,10



6870280*

Nickel matt

Glas Weiß matt

EEK: A++ bis E

4 x E14, max. 30 W

L 640

mit Schalter

€ 79,00



6870281*

Nickel matt

Glas Weiß matt,

EEK: A++ bis E

2 x E14, max. 30 W

L 350, mit Schalter

€ 59,20



6598183*

Nickel matt, Glas

Weiß satiniert

EEK: A++ bis E

E27, max. 46 W

D 300

€ 53,30

2616172.*

Aluminium und
Polycarbonat-
abdeckung Weiß

EEK: A+

30 W, LED

3000 K, 2800 lm

H 300, L 300, A 50

IP 54

€ 176,10



2616173.*

Aluminium und
Polycarbonat-
abdeckung Weiß

EEK: A+

30 W, LED

3000 K, 2800 lm

D 300, A 50

IP 54

€ 176,10



2612691.*

Nickel satiniert,

Glas Weiß

EEK: A+, 27 W, LED

3000 K, 2400 lm

H 130, D 400

LED Platine austauschbar

€ 140,40

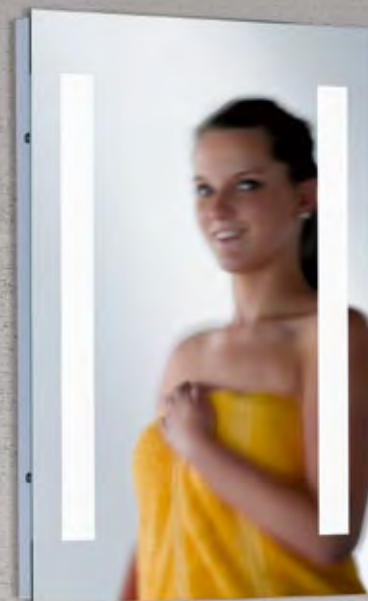

2612799.*

Weiß

EEK: B

T 8, max. 18 W

H 700, B 500

beheizbare Spiegelscheibe

mit Zugschalter

€ 247,60

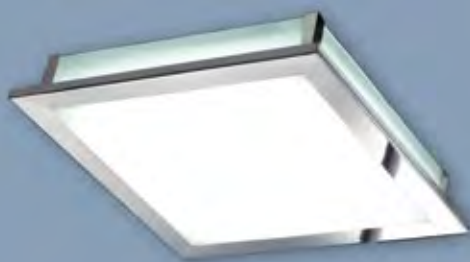

2612775.*
 Chrom,
 Glas Weiß satiniert
 EEK: A+, 18 W, LED
 3000 K, 1750 lm
 H 65, B 385, T 385
 € 191,40

o. Abb.
0644818.*
 EEK: A+
 10 W, LED
 3100 K, 980 lm
 H 65, B 295, T 295
 € 136,70



2623303.*
 Chrom poliert
 EEK: A
 16 W (32 x 0, 5 W), LED
 2700 K, 930 lm
 H 87, B 300, L 300
 € 342,70



2623302.*
 Chrom poliert
 EEK: A
 16 W (32 x 0, 5 W), LED
 2700 K, 891 lm
 H 90, D 300
 € 372,40

2623225.*
 Weiß
 EEK: A
 41 W, LED
 4000 K, 3600 lm
 H 60, B 300,
 L 1200
 € 208,10



2620891.* Weiß
 EEK: A++ bis A
 11 W, Power-LEDs, 3000 K, 950 lm
 D 270, A 70
 € 184,40



o. Abb.
2620890.* Silber
 EEK: A++ bis A, 4000 K, 950 lm
 € 184,40

Bewegungsmelder 360°



2622436.*
 Acryl Weiß
 EEK: A
 14 W, LED
 3000 K, max. 1050 lm
 D 300
 mit integriertem,
 stufenlosem Dimmer
 € 38,20



2622437.*
 Nickel matt,
 Acryl Weiß
 EEK: A, 14 W, LED,
 3000 K, max. 1050 lm
 D 310
 mit integriertem,
 stufenlosem Dimmer
 € 63,60



1567575.*
 Weiß
 EEK: A+, 12 W, LED
 3000 K, 1000 lm
 H 118, D 370
 € 178,50



2605876* Chrom, Glas Weiß
 satiniert mit silberner Dekoration
 EEK: A++ bis E
 E27, max. 46 W
 D 300
 Dekorglas
 € 64,50



2601323*
 Chrom, Glas alabasterfarbig
 Weiß, mit Dekor
 EEK: A++ bis E, E27, max. 46 W
 D 400
 € 81,50



2612111* Weiß
 Kunststoffabdeckung
 EEK: A++ bis E
 2 x E27, max. 15 W
 D 360, A 100
 € 37,40

o. Abb.
2622453*
 EEK: A++ bis E
 1 x E27, max. 15 W
 D 300, A 100
 € 30,90

Nickel matt, Glas Opal matt



o. Abb.
2622462.*
 EEK: A++ bis A
 6 W, LED
 3000 K, 400 lm
 D 180, A 80
 € 71,20

o. Abb.
2622463.*
 EEK: A++ bis A
 8 W, LED
 3000 K, 950 lm
 D 230, A 80
 € 95,00

o. Abb.
2622464.*
 EEK: A++ bis A
 18 W, LED
 3000 K, 1450 lm
 D 280, A 80
 € 106,90



2623305.*
 Chrom poliert
 EEK: A
 16 W (32 x 0, 5 W), LED
 2700 K, 985 lm
 H 97, D 280
 € 246,30

2615107.*
Stahl, EEK: A+
3,6 W, LED
3000 K, 300 lm
H 1655, L 200, B 200
inkl. Tastdimmer
€ 86,10

2615106.*
Stahl, EEK: A+
3,6 W, LED
3000 K, 300 lm
H 815, L 155, B 155
inkl. Tastdimmer
€ 65,30



2622885.*
Aluminium gebürstet
EEK: A+
10 W, LED
2700-5000 K einstellbar, 200-900 lm
H 60-1060, B 550-1000
5-stufiger Tastdimmer,
Farbtemperatur regelbar,
USB Anschluss,
mehrfach ausrichtbar
durch zwei Gelenke
€ 188,00



2622375.*
Weiß
EEK: A+
35 W, LED
4000 K, 3600 lm
L 1200, B 100, H 60,
dimmbar
€ 148,60

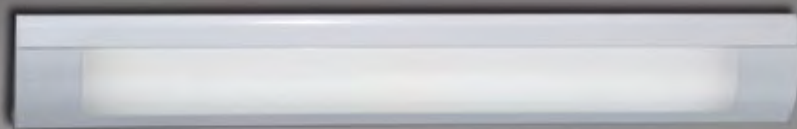

2616117.* Weiß,
Abdeckung
Kunststoff
EEK: A+
18 W, LED
3000 K, 1450 lm
B 160, L 735, A 45
€ 106,90

o. Abb.
2616118.*
EEK: A+
36 W, LED
3000 K, 2900 lm
B 160, L 1350, A45
€ 154,50

1552192*
Pendel-
länge 1500
€ 21,30



2612535* Weiß / Metall /
Diffusor Kunststoff Opal Weiß
EEK: A, 2 x G5, 35 W / 49 W
H 53, B 172, L 1500
€ 192,10

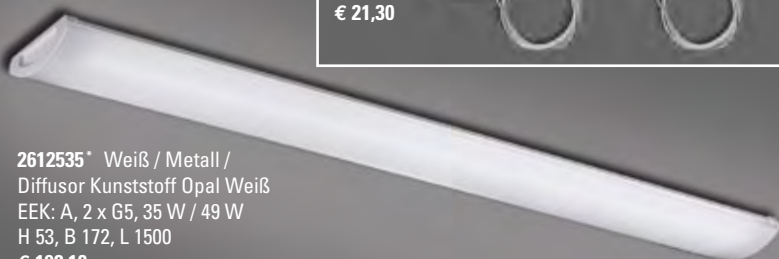

1598596.*
Aluminium eloxiert
EEK: A+
5 W, S14s, LED
2700 K, 300 lm
H 58, B 35, L 300
€ 81,80



1598597.*
Aluminium eloxiert
EEK: A+
8 W, S14s, LED
2700 K, 620 lm
H 58, B 35, L 500
€ 97,20

2622884.*
 Anthrazit
 EEK: A+
 10 W, LED
 2700-5000 K einstellbar,
 200-900 lm
 H 50-875, B 440-1200
 5-stufiger Tastdimmer,
 Farbtemperatur regelbar,
 mehrfach ausrichtbar
 durch zwei Gelenke
€ 178,50



2623234.*
 Braun metallic
 EEK: A++
 3 W, LED
 3000 K, 350lm
 L 280, B 60, H 510
 inkl. 3-Stufen-
 Touchdimmer,
 inkl. Kalender mit
 Uhrzeit, Datum und
 Temperaturanzeige
€ 74,20



2623184.*
 Champagnerfarbig
 EEK: A++ bis A
 7,6 W, LED
 3000 K, 818 lm
 H 790, B 160, A 370
 6-Stufen-Touchdimmer,
 USB Anschluss,
 verstellbar
€ 86,50



o. Abb.
2623183.*
 Eisenfarbig Grau
€ 86,50

2623147.*
 Kunststoff weiß
 EEK: A++
 4,5 W, LED
 4000 K, 550 lm
 H 325, B 120, T 480
 mit Touchdimmer
€ 33,90



2623151.*
 Stahl schwarz, Holz natur
 EEK: A++ bis E
 E14, 46 W
 H 605, B 180, D 180
 mit Kabelschalter
€ 80,90



2616197.* Silber / Schwarz
 EEK: A+, 5 W, LED
 4000 K, 650 lm
 bis H 400, Höhe verstellbar,
 4-Stufen Touchdimmer,
 mit 3-fach / 5-fach
 Vergrößerung
€ 66,60



2616185.*
 Nickel matt
 EEK: A+
 4,4 W, LED
 3000 K, 490 lm
 bis H 350 verstellbar,
 mit Schalter
€ 74,10

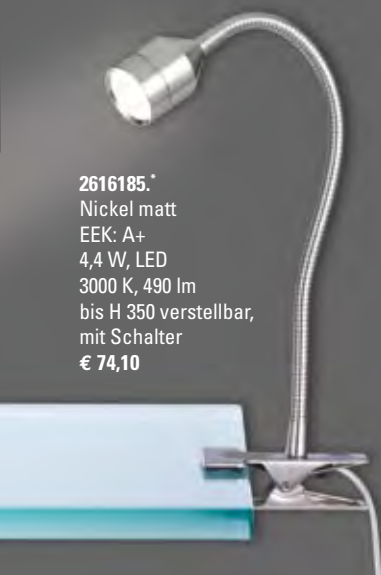

inkl. integriertem
 Schukostecker,
 EIN/AUS-Touchschalter,
 inkl. Flexarm und
 blauem Orientierungslicht

2612896.*
 Stahl, EEK: A+
 3 W, LED
 3000 K, 220 lm
 L 440, B 55
€ 116,30



2616134.*
 Weiß
 EEK: A+
 4,5 W, LED
 3000 K, 450 lm
 H 520, D 190, A 300
 flexibel,
 inkl. Kabelschalter
€ 84,40

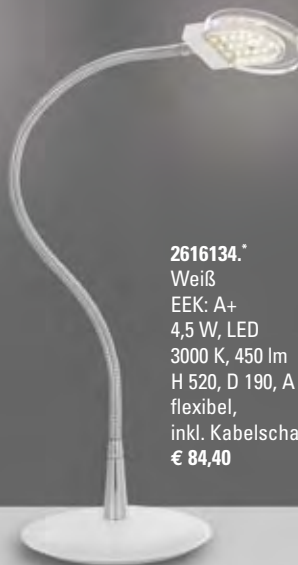

2622382.*
 Stahl
 EEK: A+
 3 W, G9
 3000 K, 245 lm
 H 720, B 185
 inkl. 3-Stufen-
 Touchdimmer
€ 89,10





2622485.* Silber
EEK: A++ bis A
3,5 W, LED, 3000 K, 280 lm
L 165, B 108, H 580, A 390
mit Touchschalter
€ 41,90

o. Abb.
2622486.* Schwarz
€ 41,90

o. Abb.
2622484.* Weiß
€ 41,90



2612803.*
Aluminiumfarbig, Weiß
glänzend, EEK: A+
6 W, LED, 5000 K, 400 lm
H 500, A 600
verstellbar,
Refll. verstellbar
€ 106,30



2612804.*
Silberfarbig
EEK: A+
6 W, LED, 5000 K, 400 lm
H 500, A 800,
mit 3-Stufen-Touchdimmer,
verstellbar
€ 131,10



2622758.*
Weiß
EEK: A
3 W, LED
2700 K, 124 lm
H 450
mit Schalter
€ 287,90

2622781.*
Weiß
EEK: A
3 W, LED
2700 K, 124 lm
H 1190
mit Schalter
€ 446,20



2622434.*
Weiß
EEK: A+
6 W, LED
3500 K, 670 lm
H 500, D 190, A 550
mit Schalter
€ 76,20

o. Abb.
2622435.*
Anthrazit
€ 76,20

2613057.*
Aluminiumfarbig
EEK: A+
10 W, LED
6500 K, 760 lm
H 720, B 210, L 300,
mit Schalter
€ 125,00



2623264.*
Ausf. Nickel matt
EEK: A+
6 W, LED
3000 K, 560 lm
H 850
mit
Tastdimmer
€ 93,00

2623265.*
Nickel matt / Chrom
EEK: A+
4,7 W, LED
3000 K, 470 lm
H 380
mit 4-fach
Touchdimmer
€ 70,00

2623165.*
EEK: A+
5 W, LED
3000 K, 440 lm
H 140, B 110, T 110
€ 94,90



2623163.*
EEK: A+
5 W, LED
3000 K, 450 lm
H 150, D 100
€ 94,90



6502093.*
EEK: C
HAL 33 W, G9
H 130, D 150
€ 62,10



2615049.*
EEK: A+
8 W, LED,
3000 K, 700 lm
H 140, D 100
€ 109,20



2623160.*
EEK: A+
5 W, LED
3000 K, 450 lm
H 240, D 160
€ 97,50

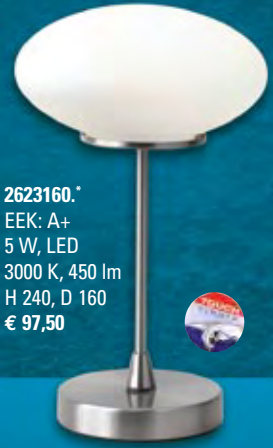

Nickel satiniert, Glas Weiß, inkl. 3-Stufen-Touchdimmer

mit Bewegungssensor
bei Dämmerung

2702314.*
Acryl weiß,
Aluminium
gebürstet
EEK: A+
2,8 W, LED
3000 K, 130 lm
L 80, B 80, A 25
€ 27,00



2623164.* Nickel satiniert,
Acryl satiniert / transparent
EEK: A+
8 W, LED, 3000 K, 660 lm
H 200, D 170
3-Stufen Touchdimmer am Fuß, seitliche
und nach unten gerichtete Beleuchtung
€ 123,70



2612266.*
Titanfarbig
EEK: A+, 3,6 W, LED
3000 K, 200 lm
H 645, B 185, T 500, A 300
mit Schalter
mit Fuß und Klemme
€ 61,60

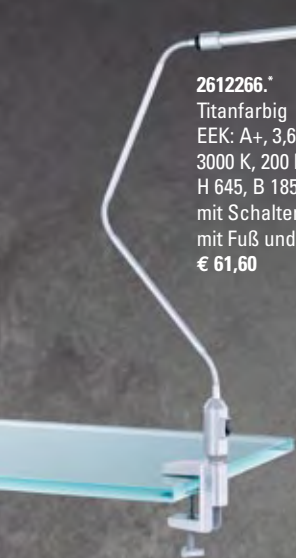

2603667.*
Aluminiumfarbig /
Chrom
EEK: A++ bis E
E14, max. 9 W,
verstellbar
bis H 450
€ 49,30



2616128.* Chrom, EEK: A+
3 W, LED, GU10
3000 K, 250 lm
H 220, D 55, A 130
inkl. Kabelschalter flexibel
€ 31,70



6574094.*
Weiß
EEK: A++ bis E
E27, max. 30 W
H 342, B 130,
T 130, A 200
mit Schalter
€ 17,20



2600423.*
Stahlfarbig
EEK: A++ bis E
E27, max. 30 W
H 342, B 130,
T 130, A 200
mit Schalter
€ 17,20



2605815.*
Chrom / silberfarbig
EEK: A
E14, max. 30 W
H 350, verstellbar
€ 36,90



2-Phasen Hochvolt-Schienensystem, Nickel matt – M6 Licht / HV-Track 4



2605828.*
Spotkopf 1-flg.
Nickel matt
EEK: D
50 W, GZ10
2900 K, 300 lm
H 150
€ 76,20



2613017*
Spotkopf 1-flg.
Nickel matt
EEK: A+ bis E
GZ10,
max. 50 W
H 130
€ 73,70



2616242*
Spotkopf 1-flg.
Nickel matt
EEK: A+ bis E
GZ10,
max. 50 W
H 120
€ 73,70

2616246.*
Pendel ohne
Glas 1-flg.
Nickel matt / chrom
EEK: A++ bis A
5,5 W, LED
2700 K, 612 lm
D 80, H 950-1500
höhenverstellbar
€ 237,70

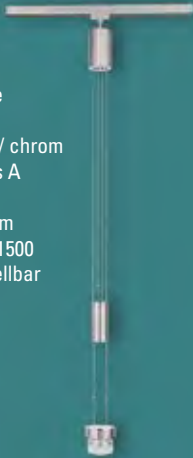

2616237
Glas alabasterfarben
D 180, H 160
€ 37,20



2616238
Glas opal gewischt
D 160, H 160
€ 45,20

2616244.*
Spotkopf 1-flg.
Nickel matt
EEK: A++ bis A
6,3 W, LED
3000 K, 726 lm
B 140, D 120, A 225
€ 190,20



2615072.*
Spotkopf 1-flg.
Nickel matt
EEK: A++ bis A
6,7 W, LED
3000 K, 717 lm
B 21, L 52, A 209
€ 190,20



2615075*
Spotkopf ohne Glas
EEK: A+ bis E
GU10, max. 35 W
B 21, L 52, A 130
€ 92,80

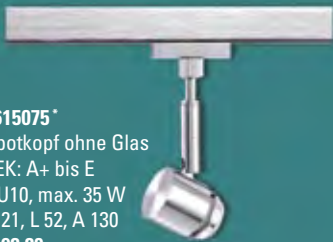

2616235
Glas opal gewischt
D 65, H 72
€ 10,70



2615066
Glas teilsatiniert, Rand klar
D 65, H 72
€ 10,70



2605835
Stromschiene
L 1000
€ 65,50

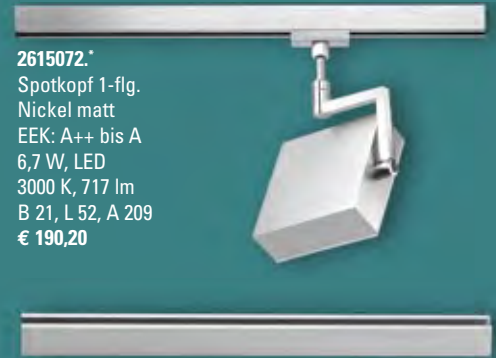

o. Abb.
2605839
L 1400
€ 92,80

o. Abb.
2605841
L 1800
€ 122,50

2605860 Stromschiene-
Einspeisung
L 1500
Baldachin mit Kabel
€ 76,20

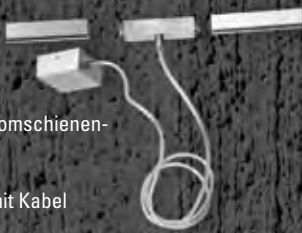

2612022
Strom-
schiene-
Verbinder
L 200
schwenkbar
€ 57,10

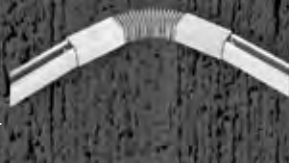

2605858 Stromschiene
Endeinspeisung,
B 85, H 40, L 115
€ 89,00



2605862
Stromschiene-Endkappe,
B 23, L 25
€ 6,00

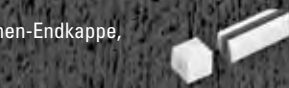

Nickel matt
HV-Track 4

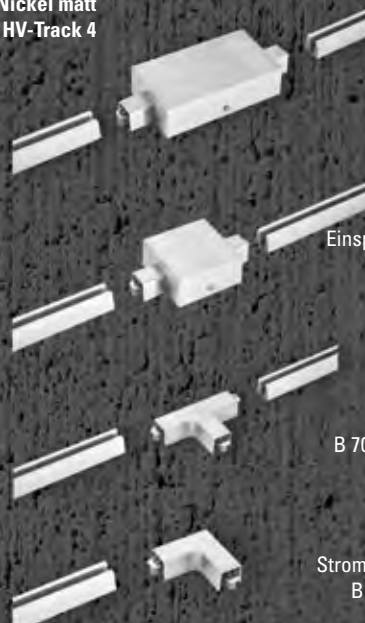

2605856
Stromschiene
Mitteneinspeisung
mit Serienschaltung
B 85, H 40, L 210
€ 237,70

2612704
Stromschiene-
Einspeisung, Nickel matt
Mitteneinspeisung
B 85, H 40, L 145
€ 101,20

2605871
Stromschiene-
Verbinder
B 70, L 110, T-Verbinder
€ 135,70

2605869
Stromschiene-Verbinder
B 70, L 70, 90° Winkel
€ 59,50



2615076*
Pendel ohne Glas,
Kabeltransparent
EEK: A++ bis E
E27, max. 50 W
B 21, L 2354
sichtbare
Kabellänge: 2200
€ 118,80



2615065
Glas alabaster-
farben
D 200, H 200
€ 23,60



2616345
Glas Opal gewischt
D 200, H 200
€ 37,20

Hochvolt-Schienensystem, Nickel matt – M6 Licht / HV-Track 3

Kombinieren Sie Ihre Wunschleuchte aus Grundelementen + Gläsern

Grundelemente

2615074*
Spotkopf
ohne Glas
1-flg.
Nickel matt
EEK: A+ bis E
GU10, max. 35 W
D 37, L 115
€ 78,50



Gläser



2615068
Metallschirm
Chrom
D 58, H 61
€ 6,00



2615067
Glas Opal
glänzend
D 65, H 72
€ 10,70

2616245*
Pendel ohne Glas
1-flg.
Nickel matt / chrom
EEK: A++ bis A
5,5 W, LED
2700 K, 612 lm
D 80, H 950-1500
höhenverstellbar
€ 226,00

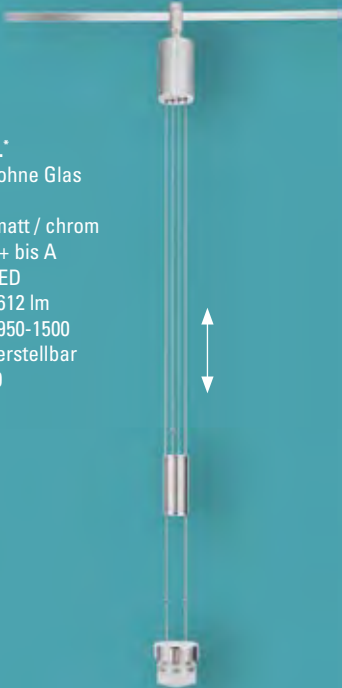

2616240
Glas teilsatiniert,
Rand klar
D 150, H 160
€ 45,20



2623175
Glas Opal gewischt
D 180, H 160
€ 47,10



2615065
Glas alabasterfarben
D 200, H 200
€ 23,60

2616376.*
Spotkopf
1-flg.
Nickel matt
EEK: D
GZ10, max. 50 W
2900 K, 300 lm
H 120
€ 61,80



2622472.*
Spotkopf
1-flg.
Nickel matt / Chrom
EEK: A++ bis A
5,3 W, LED
3000 K, 420 lm
D 95, H 160
€ 95,00



2612023.*
Spotkopf
Nickel matt
EEK: D
50 W, GZ10
2900 K, 300 lm
H 150
€ 67,70



2603524
Einspeisung
Nickel matt
Zuleitung 700
€ 58,30



2603525
Deckenhalter
Nickel matt
H 106
€ 23,60

2603527
Stromschiene
Nickel matt
H 20, L 1800
€ 149,80

o. Abb. **2603526**
H 20, L 1400
€ 97,50



2605850
Stromschiene
Nickel matt
H 110, D 105
€ 73,70

2603528
Stromschienen-Verbinder
Nickel matt
L 72, starr
€ 45,20



2603529
Stromschienen-Verbinder
Nickel matt
L 128, schwenkbar
€ 61,80



Edelstahl



Eisen
EEK: A bis C
GU 5,3, 12 V, 50 W
D 80, DA 68, ET 55



- 6075665* Weiß € 23,80
- 6075663* Chrom € 25,40
- 6075666* Nickel matt € 32,80
- 6075667* Edelstahl € 47,90

Nickel matt



Eisen
EEK: A bis C
GX 5,3, 12 V, 50 W
D 82, DA 68, ET 55



- 1419015* Weiß € 21,90
- 1419012* Chrom € 25,20
- 1419016* Nickel matt € 31,80
- 6075668* Edelstahl € 48,00

Chrom matt



Eisen
EEK: A bis C
GX 5,3, 12 V, 50 W
D 82, DA 68, ET 55



- 6075412* Weiß € 14,20
- 6075410* Chrom € 20,10
- 1422065* Chrom matt € 25,90
- 6075411* Gold € 21,00

Chrom matt



Druckguss
EEK: A bis C
GX 5,3, 12 V, 50 W
D 82, DA 68, ET 55



- 6075672* Weiß € 16,50
- 6075669* Chrom € 22,90
- 6075670* Chrom matt € 25,70

Chrom



Druckguss
EEK: A bis C
GX5,3, max. 50 W
ohne Sprengring
D 88, DA 68, ET 55



- 2605566* Weiß € 21,50
- 2605562* Chrom € 24,50
- 2605568* Nickel matt € 30,80
- 2612495* Chrom matt € 30,80
- 2605564* Gold € 27,80

Chrom



EEK: A bis C
GX 5,3, max. 50 W
D 83 x 83, DA 68, ET 55



- 2613061* Weiß € 25,70
- 2613058* Chrom € 26,60
- 2613059* Chrom matt € 32,30
- 2613062* Nickel matt € 32,40
- 2613060* Gold € 29,70

Alu matt



EEK: A bis C
GX 5,3, 12 V, max. 50 W
ohne Sprengring
D 82, DA 68, ET 55



- 2613227* Weiß € 21,70
- 2601468* Alu matt € 21,70
- 3703299* Champagner € 27,00
- 3703300* Titan € 27,00

Alu matt



EEK: A bis C
GX 5,3, 12 V, max. 50 W
ohne Sprengring
D 82 x 82, DA 68, ET 55



- 2615425* Weiß € 24,40
- 2601479* Alu matt € 24,40
- 3703301* Champagner € 29,60
- 3703302* Titan € 29,60



- 5804793*
Glas satiniert
EEK: A++ bis A
4 W, LED, 3000 K, 320 lm
D 62, DA 52, ET 60, H 12
€ 80,90

Weiß



- EEK: A++ bis A
12 W, LED, 3000 K, 887 lm
Dim2 warm
D 82, DA 74, ET 48

- 3002442.* Weiß € 110,60
- 3002443.* Alu € 121,60

Weiß



- EEK: A++ bis A
6 W, LED, 3000 K, 507 lm
Dim2 warm
D 82, DA 68, ET 32

- 3002452.* Weiß € 70,00
- 3002453.* Alu € 74,80

Weiß



- EEK:
A++ bis A
6 W, LED, 3000 K, 507 lm
Dim2 warm
D 82 x 82, DA 68, ET 32

- 3002454.* Weiß € 73,60
- 3002455.* Alu € 78,40

LED-Konverter, Weiß
L 180, B 32, H 32

o. Abb.
1405158
350 mA, 17 W
nicht dimmbar
€ 86,80

o. Abb.
1405203
350 mA, 17 W, 1-10 V
dimmbar
€ 99,30

o. Abb.
1405204
350 mA, 17 W, DALI
dimmbar
€ 99,30

o. Abb. 1407061
LED-Konverter
350 mA, 2-20 W
nicht dimmbar
L 145, B 50, H 22
€ 67,90

o. Abb.
1407062
LED-Konverter
350 mA, 10,5 - 30 W
dimmbar
L 122, B 39, H 18
€ 61,70

o. Abb. 1405420
LED-Konverter
350 mA, 6,3 - 33 W
nicht dimmbar
L 68, B 35, H 21
€ 31,10

o. Abb.
1405280
LED-Konverter
L 140, B 44, H 30
Phasenabschnitt dimmbar
350 mA, 10,5 - 18 W
€ 61,70



6075508
HV Fassung
inklusive Bügel
€ 12,50



1325817*
LED MR16 Einsatz
EEK: A, 6 W, LED
2700 K, 540 lm
D 50, ET 40
Drehwinkel 270°
€ 59,50

o. Abb.
1325818*
EEK: A
3000 K, 540 lm
€ 59,50

Chrom satiniert



Druckguss
EEK: A++ bis E
GX 5,3, 12 V, 50 W
D 83 x 83, DA 75, ET 55



- 1421436* Chrom € 21,30
- 1421437* Chrom satiniert € 21,30
- 1421438* Chrom matt € 21,30

Chrom matt



Druckguss
EEK: A++ bis E
GX 5,3, 12 V, 50 W
D 82, DA 75, ET 55



- 1421128* Weiß € 15,40
- 1421129* Chrom € 18,90
- 1421131* Chrom matt € 18,90
- 1421295* Chrom satiniert € 18,90
- 1421132* Gold € 18,90
- 1421133* Altmessing € 18,90

Chrom



Druckguss
EEK: A++ bis E
GX 5,3, 12 V, 50 W
D 78, DA 68, ET 55



- 1421140* Weiß € 11,80
- 1421142* Chrom € 14,20
- 1421144* Chrom matt € 14,20
- 1421294* Chrom satiniert € 14,20
- 1421146* Gold € 14,20



1422049* Edelstahl
EEK: A bis C
GX 5,3, 12 V, 50 W
D 80, DA 65, ET 55
€ 26,30



2603886* Edelstahl
EEK: A bis C
GX 5,3, 12 V, max. 50 W
D 82 x 82, DA 68, ET 55
ohne Sprengring
€ 96,80



1541333* Alu matt
EEK: A bis C
1 x GX 5,3, max. 50 W
D 90 x 90, DA 80 x 80, ET 60
€ 47,40



Chrom



Eisen
EEK: A++ bis E
GX 5,3, 12 V, 50 W
D 105, DA 80, ET 55

- 1421065* Weiß € 11,80
- 1421066* Chrom € 15,40
- 1421811* Chrom matt € 15,40
- 1421068* Chrom satiniert € 15,40
- 1421069* Messing € 15,40
- 1421070* Altmessing € 15,40



Einbaulautsprecher



6076048
Weiß
4 Ohm, 8 W
D 100, DA 93, ET 42
€ 94,70

Weiß



EEK: A++ bis A
350 mA, 3 W, LED
2700 K, 260 lm
D 82, DA 68, ET 40
ohne Konverter



- 1552197.* Weiß € 44,10
- 1578443.* Chrom € 47,80
- 1406814.* Alu € 44,10

Champagner



EEK: A++ bis A
350 mA, 7 W, LED
2700 K, 710 lm
D 82, DA 68, ET 30

- 1567790.* Chrom € 57,10
- 1567793.* Weiß € 55,90
- 1567794.* Alu matt € 60,60
- 3703306.* Champagner € 66,60
- 3703307.* Titan € 66,60



Chrom



EEK: A++ bis A
350 mA
3 W, LED
2700 K, 260 lm
D 82 x 82,
DA 68, ET 40

- 1579613.* Weiß € 47,60
- 1578444.* Chrom € 51,10
- 1579614.* Alu € 47,60



Titan



350 mA
7W, LED
EEK: A++ bis A
2700 K, 710 lm
D 82 x 82,
DA 68, ET 30

- 1579621.* Weiß € 59,50
- 1579622.* Chrom € 60,60
- 1579623.* Aluminium € 64,20
- 3703308.* Champagner € 70,20
- 3703309.* Titan € 70,20



2612183.* Weiß Struktur
EEK: A++ bis A, 11 W, LED
warm-weiß, 3000 K, 600 lm
D 200, DA 180, ET 30
€ 154,50

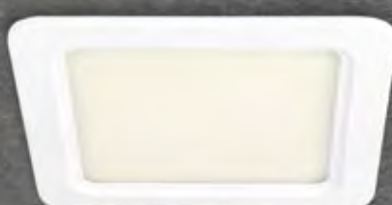

2612184.* Weiß Struktur
EEK: A++ bis A, 12 W, LED
warm-weiß, 3000 K, 600 lm
D 180 x 180, DA 160 x 160, ET 30
€ 154,50



2612181.* Weiß Struktur
EEK: A++ bis A, 6 W, LED
warm-weiß, 3000 K, 200 lm
D 140, DA 120, ET 30
€ 93,60



2612182.* Weiß Struktur
EEK: A++ bis A, 5 W, LED
warm-weiß, 3000 K, 200 lm
D 100 x 100, DA 90 x 90, ET 30
€ 93,60

Edelstahl



EEK: A+
350 mA, 6 W, LED, 3000 K, 620 lm
H 32, D 83, A 68
inkl. dimmbarem Netzgerät

2616454.* Edelstahl € 89,20
2616450.* Weiß € 89,20
2616452.* Chrom € 89,20
2616456.* Aluminium € 89,20



5804794.*
Weiß
EEK: A++ bis A
500 mA, 5 W, LED
3000 K
D 95, DA 83, ET 48
€ 71,20



1578440.* Weiß
EEK: A++ bis A,
3,6 W, LED
3000 K, 350 lm
H 17, D 65
Ein- / Aufbauvariante, IP 20
€ 64,30



1405476
LED-Konverter
gehört zu 1578440.*
350mA, nicht dimmbar
L 52, B 30, H 23
€ 34,00



inkl. speziellem Stecksystem zur
Weiterverdrahtung, zusätzlich Zubehör #1
erhältlich

2612189.* #1 Titan
EEK: A++ bis A
2 W, LED
warm-weiß, 3000 K
D 70, DA 56-60, ET 14
€ 63,50

ohne Abb. 1404740*
Netzgerät für LED-
Möbeleinbau
passend zu #1
€ 55,80

ohne Abb. 1404741*
6-fach Verteiler für
LED-Möbeleinbau,
passend zu #1
€ 12,90

ohne Abb. 1404742*
Verbindungsleitung
2000 mm für LED-
Möbeleinbau
passend zu #1
€ 9,40

Weiß



Aluminium
EEK: A++ bis A, 350 mA, 3 W, LED,
3000 K, 300 lm, D 68, DA 60, ET 16,5

2616307.* Weiß € 41,50
2616309.* Alu € 41,50
2616308.* Schwarz € 41,50

Edelstahl

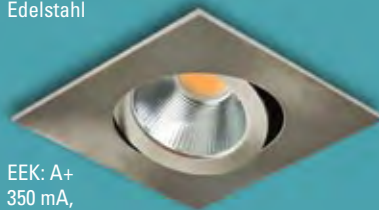

EEK: A+
350 mA,
6 W, LED, 3000 K, 620 lm
H 32, L 83, B 83, A 68
inkl. dimmbarem Netzgerät

2616470.* Edelstahl € 95,10
2616468.* Chrom € 95,10
2616466.* Weiß € 95,10
2616472.* Aluminium € 95,10



EEK: A++ bis A,
12 V DC, 5 W, LED, 3000 K, 375 lm
D 75, ET 14, DA 68, IP 44

2622569.* Nickel matt € 57,70
2622568.* Chrom € 57,70
Aufbau-ring, H 15
2622584.* Nickel matt € 14,70
2622583.* Chrom € 14,70



5804799.* Kunststoff satiniert
EEK: A++ bis A
350 mA, 10 W, LED, 3000 K, 690 lm
D 89, DA 83, ET 70, H 20
€ 86,60



2613748.* Weiß
EEK: A++ bis A
11 W, LED, 3000 K, 770 lm
D 110, DA 83, ET 80
indirekte Ambientebeleuchtung
€ 149,50

Chrom matt



Druckguss
EEK: A++ bis E
GX 5,3, 12 V, 50 W
IP 65
D 84, DA 68, ET 80

1421439* Weiß € 29,60
1421440* Chrom € 35,60
1421441* Chrom satiniert € 35,60
1421442* Chrom matt € 35,60



EEK: A++ bis A, 6 W, LED, 3000 K, 600 lm
D 82 x 82, DA 68, ET 45, IP 65

3002448.* Weiß € 79,60
3002447.* Aluminium € 76,20
5804797.* Champagner € 86,90
5804798.* Titan € 86,90

Aluminium



EEK: A++ bis A, 6 W, LED, 3000 K, 600 lm
D 82, DA 68, ET 45, IP 65

3002445.* Weiß € 73,70
3002446.* Aluminium € 77,10
5804795.* Champagner matt € 84,40
5804796.* Titan matt € 84,40



2613749.* Weiß
EEK: A++ bis A
13,6 W, LED
3000 K, 950 lm
D 102, DA 92, ET 90
€ 105,90



2613750.* Weiß
EEK: A++ bis A
13,6 W, LED
3000 K, 950 lm
D 102 x 102, DA 92, ET 90
€ 105,90



2616314 Reduzierring Weiß
für Einbaustrahler mit Außendurch-
messer 84 - 87 mm, als Adapter für
Deckenausschnitt 100 - 160 mm
D 180, DA 100-160, ET 50
€ 37,70



LED-Konverter, Weiß
L 180, B 32, H 32

1405205
700 mA, 33 W
nicht dimmbar
€ 86,80

1405206
700 mA, 33 W,
1-10 V
dimmbar
€ 99,30

1405207
700 mA, 30 W, DALI
dimmbar
€ 99,30

1404739
700 mA, 33 W
Phasenabschnitt
dimmbar
€ 99,30

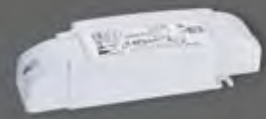

LED-Konverter, Weiß
L 140, B 44, H 30

1405294
Phasenabschnitt dimmbar
700 mA, 9,8-20 W
€ 62,30



2613038.*
Aluminium
EEK: A++ bis A
10 W, LED, 3000 K, 600 lm
H 43, D 110, DA 95, IP 65
€ 149,90



2613037.*
Aluminium
EEK: A++ bis A
2 x 5,5 W, LED, 3000 K, 330 lm
H 35, D 80, DA 67, IP 65
2er-Set
€ 149,90



5102494.* Weiß
EEK: A
350 mA, 7 W, LED
3000 K, 345 lm
H 38, D 106,
A 92, ET 38
€ 47,50

o. Abb.
1404298.*
Vorschaltgerät
350 mA, 5,25 - 18 W
H 28, L 113, B 44
dimmbar über Phasen-
an- und abschnitt-
Dimmer
€ 51,10



5102496.* Weiß
EEK: A
350 mA, 14 W, LED
3000 K, 773 lm
H 52, D 146,
A 132, ET 52
€ 63,00

o. Abb.
1406843.*
Vorschaltgerät
350 mA, 13 - 25 W
H 28, L 113, B 45
dimmbar über
Phasen-an- und
abschnitt-Dimmer €
€ 65,30



1578445.*
Weiß
EEK: A++ bis A
15 W, LED
3000 K, 1100 lm
D 105, DA 92, ET 80
50° schwenkbar
€ 92,50



2622544.* Weiß
EEK: A+
8,4 W, LED, 3000 K, 1010 lm
D 83, ET 45, LA 68
inklusive universell
dimmbaren Vorschaltgerät
IP 65, schwenkbar
€ 118,90

o. Abb.
2622546.*
Chrom
EEK: A+
€ 118,90

o. Abb.
2622548.*
Edelstahl
EEK: A+
€ 118,90

o. Abb.
2622550.*
Aluminium
EEK: A+
€ 118,90

o. Abb.
2622552.*
Chrom matt
EEK: A+
€ 118,90



2613752.* Weiß
EEK: A++ bis A
9,8 W, LED
3000 K, 760 lm
H 104,5, D 100
90° schwenkbar
355° drehbar
€ 239,90



2615063.*
Schwarz /
Weiß
EEK: A++ bis A
26 W, LED
3000 K, 2210 lm
H 184, D 127
€ 343,50

90° schwenkbar,
355° drehbar



2615056.*
Strukturschwarz matt, Gold
EEK: A++ bis A
4 W, LED
3000 K, 300 lm
H 80, D 79
€ 173,00



2613755.* Silber
EEK: A++ bis A
5,3 W, LED
3000 K, 325 lm
H 23, D 88
€ 64,20

o. Abb.
2613757.* Weiß
EEK: A++ bis A
5,3 W, LED
3000 K, 325 lm
H 23, D 88
€ 64,20

o. Abb.
2613756.* Silber
4000 K, 325 lm
€ 64,20

o. Abb.
2613758.* Weiß
4000 K, 325 lm
€ 64,20



2615061.*
Strukturweiß
EEK: A++ bis A
7 W, LED
3000 K, 450 lm
IP 54
H 80, L 80 x 80
€ 165,10



2615060.*
Strukturweiß
EEK: A++ bis A
7 W, LED
3000 K, 450 lm
IP 54
H 85, L 70 x 70
€ 193,40



3002438.*
Weiß
EEK: A++ bis A
9,8 W, LED
3000 K, 720 lm,
D 100 x 100,
H 110,5
€ 249,60



3002439.*
Weiß
EEK: A++ bis A
6 W, LED
3000 K, 540 lm
D 85, H 95
€ 128,80



3703305.*
Weiß
EEK: A++ bis A
13 W, LED
3000 K, 810 lm,
D 140, H 50
€ 204,60



6500890*
Edelstahl
EEK: A++ bis E
E27, max. 57 W
H 345, B 210, A 255
€ 234,40



3205224*
Edelstahl
EEK: A++ bis E
E27, max. 57 W
H 365, B 210, A 230
€ 297,50

Bewegungsmelder 120°

3208073*
Edelstahl
EEK: A+
10 W, LED
3000 K, 770 lm
H 370, B 180, A 85
€ 381,90



2623202.*
Graphit
EEK: A++
10 W, LED
3000 K, 500 lm
H 220, B 100, A 40
€ 113,00

Bewegungsmelder 90°



3205285*
Edelstahl,
EEK: A++ bis E
E27, max. 46 W
H 375, D 275, A 325
€ 121,50

Bewegungsmelder 360°



6501296*
Edelstahl
EEK: A++ bis E
E27, max. 57 W
H 230, B 250, A 150
€ 171,30

Bewegungsmelder 240°



1409504*
Weiß
EEK: A++ bis E,
E27, max. 46 W
H 335,5, B 215,
A 249,5
€ 113,00

o. Abb.
1409503*
Schwarz
€ 113,00



6502544*
Edelstahl / Anthrazit
EEK: A++ bis E,
E27, max. 57 W
H 345, B 200, A 95
€ 291,50

Bewegungsmelder 120°



6501830*
Edelstahl
EEK: A++ bis E
E27, max. 57 W
H 355, B 200, A 95
€ 295,10



3205232*
Edelstahl
EEK: A++ bis E
20 W TC-DSE,
E27
H 400, B 100,
A 145
€ 323,60



Lichtaustritt verstellbar durch schwenkbare Blende



2623201.*
Graphit
EEK: A++ bis A
9 W, LED
3000 K, 936 lm
H 150, B 100, A 70
€ 201,00

o. Abb.
2623200.*
Weiß
EEK: A++ bis A
€ 201,00



3239017*
Silber
EEK: A++ bis A
8,2 W, LED
3000 K, 663 lm
H 364, B 61, T 65
€ 195,10

o. Abb.
3239016*
Anthrazit
€ 195,10



Bewegungsmelder 360°

Bewegungsmelder 160°

3235123.*
Anthrazit
EEK: A++ bis A
10,5 W, LED
4000 K, 550 lm
H 241, B 66, T 201€
€ 140,40

o. Abb.
3235122.*
Weiß
€ 140,40



3239682.*
Anthrazit / Gehäuse
Aluminium Druckguss
EEK: A+
6 W, LED
3000 K, 540 lm
H 160, B 200, T 50
€ 112,90

o. Abb.
3239672.*
mit Bewegungsmelder
€ 124,80

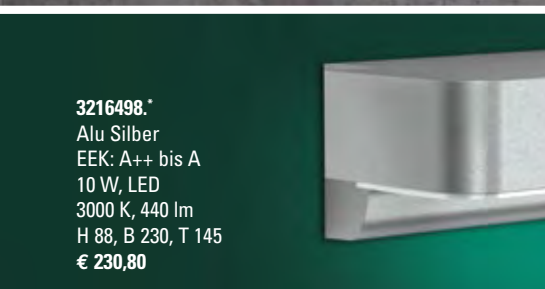

3216498.*
Alu Silber
EEK: A++ bis A
10 W, LED
3000 K, 440 lm
H 88, B 230, T 145
€ 230,80



Bewegungsmelder 160°



3235104.*
Anthrazit
EEK: A++ bis A
12,5 W, LED
3000 K, 612 lm
H 88, B 230, T 145
€ 245,10

o. Abb.
3212399.*
Silber
€ 245,10

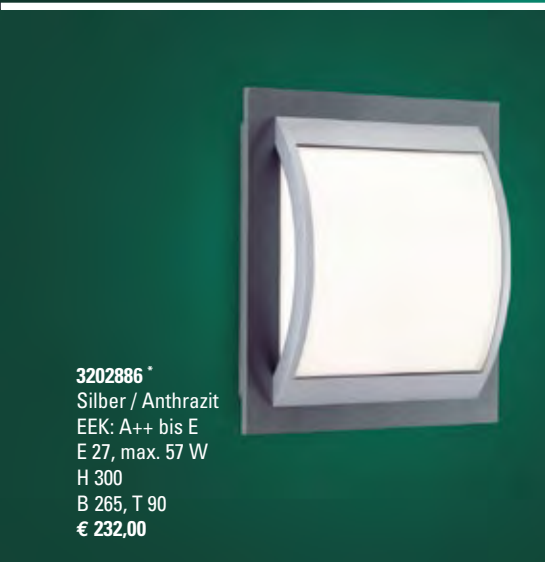

3202886*
Silber / Anthrazit
EEK: A++ bis E
E 27, max. 57 W
H 300
B 265, T 90
€ 232,00



1598718.*
Silber Metallic
EEK: A+
12 W, LED
3000 K, 590 lm
H 63
L 240, B 240
€ 294,20

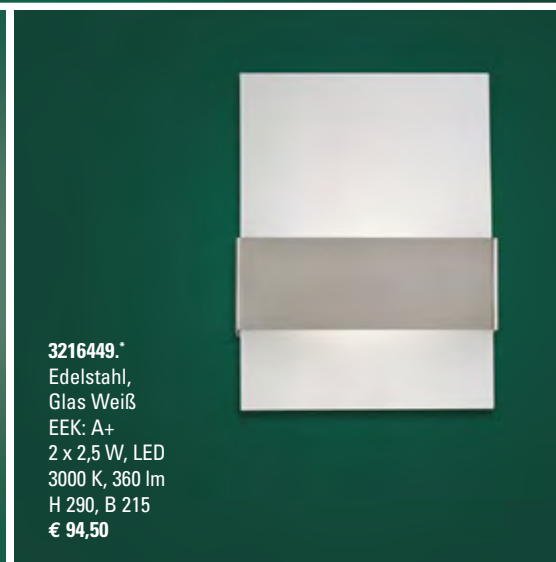

3216449.*
Edelstahl,
Glas Weiß
EEK: A+
2 x 2,5 W, LED
3000 K, 360 lm
H 290, B 215
€ 94,50



3239678*
Schwarz
EEK: A++ bis E
E27, max. 46 W
H 350, B 160, A 100
€ 308,20



3239679*
Schwarz
EEK: A++ bis E
E27, max. 46 W
H 350, B 130, A 100
€ 282,00



3216831*
EEK: A++ bis B
H 400, B 110, A 180
€ 252,20

o. Abb.
3216833*
EEK: A++ bis B
H 440
Bewegungsmelder 360°
€ 312,90

Schwarz, Aluminiumguss, Opalglas E27, 20 W TC-DSE

3216834*
EEK: A++ bis B
H 900, D 110
€ 378,40

3216875*
EEK: A++ bis B
H 500, D 110
€ 266,50



3239673.* Anthrazit /
Gehäuse Aluminium
Druckguss
EEK: A+
12 W, LED
3000 K, 720 lm
L 190, B 120, A 155
€ 124,80



o. Abb.
3239674.*
EEK: A+
Bewegungsmelder
€ 148,60



LED tauschbar,
Bewegungsmelder 90°

2623140.*
Stahl verzinkt
Schwarz,
Kunststoff klar
EEK: A+
2 x 3,7 W, LED
3000 K, 560 lm
H 195, T 130, A 140 €
€ 100,90

o. Abb.
2623141.* Weiß
EEK: A+
€ 100,90

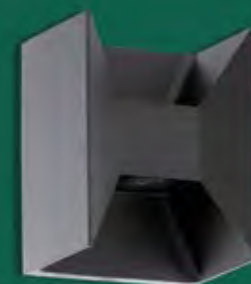

3216441.*
Aluguss Anthrazit
EEK: A+
2 x 2,5 W LED,
3000 K, 360 lm
H 180, L 140
€ 81,00



2622557.*
EEK: A++ bis A
9 W, LED
3000 K, 665 lm
230 V, IP 54
L 135, B 135, A 48
€ 127,20

o. Abb. **2622558.***
Silber € 127,20
o. Abb. **2622543.***
Schwarz € 127,20

mit wechselbarer Frontplatte



3226157.*
Weiß
EEK: A++ bis A
9 W, LED
3000 K, 665 lm
230 V, IP 54
D 145, A 47
€ 118,80

o. Abb. **3226167.***
Silber € 118,80
o. Abb. **3226166.***
Schwarz € 118,80

3235121.*
Weiß
EEK: A++ bis A
10,5 W, LED
4000 K, 690 lm
H 120, B 160, T 107
€ 119,00

o. Abb.
3235120.*
Anthrazit
EEK: A+
€ 148,60



Bewegungsmelder 160°

3216437.*
Stahl
Anthrazit / Weiß,
EEK: A+
2 x 2,5 W, LED
3000 K, 360 lm
H 260, L 150
€ 81,00



6501531*
Edelstahl
EEK: A++ bis E
E27, max. 57 W
H 380, B 103, A 170
€ 297,50

Bewegungsmelder 360°

Bewegungsmelder 360°

6502211*
Edelstahl
EEK: A++ bis E
E27, max. 57 W
H 305, B 250, A 110
€ 290,30

Bewegungsmelder 120°

3203506*
Edelstahl
EEK: A++ bis E
E27, max. 57 W
H 900, D 103
€ 572,30



3232366.*
Aluguss Weiß,
Kunststoff Weiß
EEK: A+
10 W, LED
3000 K, 1000 lm
D 180, A 45
€ 108,00

o. Abb.
3232367.*
Aluguss Anthrazit,
Kunststoff Weiß
EEK: A+
€ 108,00



3232365.*
Aluguss Anthrazit,
Kunststoff Weiß
EEK: A+
10 W, LED
3000 K, 1000 lm
H 180, L 180, A 45
€ 108,00

o. Abb.
3232364.*
Aluguss Weiß,
Kunststoff Weiß
EEK: A+
€ 108,00



2203176.*
Edelstahl
EEK: A+
0,03 W, LED
4000 K, SDCM 5
H 227, B 242, T 51
solarbetrieben
€ 126,10



3207557.*
Silber
EEK: A++ bis A
16 W, Power-LEDs
3200 K, 320 lm
H 304,5, B 291, T 104
€ 315,30

o. Abb.
3207558.* Anthrazit
EEK: A++ bis A
€ 315,30

Bewegungsmelder 360°



3239014*
Anthrazit
EEK: A++ bis A
8,2 W, LED
3000 K, 663 lm
H 364, B 211, T 65
€ 209,40

o. Abb.
3239015* Silber
EEK: A++ bis A
€ 209,40

Bewegungsmelder 360°



Bewegungsmelder 140°

6402330.*
Alu Anthrazit,
EEK: A+
1,2 W LED
4000 K, 150 lm
H 298, B 189, T 186,5
solarbetrieben
€ 278,40

o. Abb.
3212410.*
Weiß
EEK: A+
€ 265,30

o. Abb.
3212411.*
Silber
EEK: A+
€ 278,40



3231595.* Weiß
EEK: A++ bis A
24,8 W Power-LEDs
4000 K, 2400 lm
H 165, B 265, T 126
€ 379,60

o. Abb.
3231594.* Schwarz
EEK: A++ bis A
€ 379,60



3231596.* Schwarz
EEK: A++ bis A
24,8 W Power-LEDs
4000 K, 2400 lm
H 188, B 265, T 126
€ 391,50

o. Abb.
3231597.* Weiß
EEK: A++ bis A
€ 391,50

Bewegungsmelder 240°



3231589.* Weiß
EEK: A++ bis A
24,8 W Power-LEDs
4000 K, 2400 lm
H 208, B 178, T 130
€ 379,60

o. Abb.
3231602.* Schwarz
EEK: A++ bis A
48 W Power-LEDs,
4000K, 4400 lm
€ 439,10

3231592.* Schwarz
EEK: A++ bis A
48 W Power-LEDs
4000 K, 4400 lm
H 230, B 178, T 130
€ 451,00

o. Abb.
3231593.* Weiß
EEK: A++ bis A
48 W Power-LEDs,
4000K, 4400 lm
€ 451,00

Bewegungsmelder 240°

1412283*
Schwarz
€ 89,20

o. Abb.
1412282*
Weiß
€ 89,20

Bewegungsmelder 130°

EEK: A++ bis E
E27, max. 26 W
H 275, B 215, A 250

3205540*
Weiß
€ 89,20

o. Abb.
3205542*
Schwarz
€ 89,20



3216536 Anthrazit
mit 1,8 m Zuleitung
und Schuko-stecker
EEK: A++ bis E
230 V, GU 10,
max. 11 W
H 380, L 165, D 65
€ 71,30



3216535 Anthrazit
mit 1,8 m Zuleitung
und Schuko-stecker
EEK: A++ bis E
230 V, GU 10,
max. 11 W
H 380, L 165, D 65
€ 71,30



6502543
Schwarz
Steckdosenspieß
4-fach
Kabel 2,5 m
H 485, B 120
€ 220,10

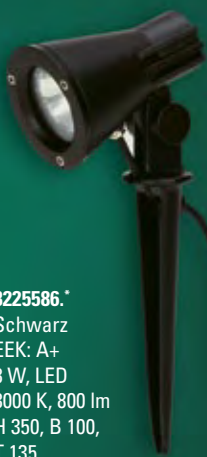

3225586
Schwarz
EEK: A+
8 W, LED
3000 K, 800 lm
H 350, B 100,
T 135
€ 252,20



3225587
Schwarz
EEK: A+
8 W, LED
3000 K, 800 lm
H 170, B 100,
T 135
€ 258,20



3232339
Aluminium
EEK: A
3 W, LED
3000 K, 300 lm
B 70, H 300
€ 117,80



Steckdosensäulen



6500257
Schwarz
4-fach,
H 500
€ 287,90

6500289
Schwarz
2-fach,
H 500
€ 228,40

3216435 Edelstahl,
Kunststoff grün
Steckdosensäule 4-fach,
H 400, B 115, L 115
€ 94,50



3216446
Kunststoff Schwarz
EEK: A+
3 W, LED, GU 10
H 185
mit Kabel
€ 27,00



3216396
Edelstahl,
Steckdosensäule
2-fach,
H 300, B 100, A 50
€ 189,20



2623146
Stahl,
Kunststoff Schwarz
H 400, B 115, T 115
mit Timer
€ 67,90

o. Abb.
2623145
Edelstahl,
Kunststoff grün
€ 80,90



3216448
Kunststoff
Schwarz
H 400,
B 115, L 115
€ 60,80



3232338.*
Schwarz
EEK: A
4 W, LED
3000 K, 260 lm
B 120, H 400
€ 82,10

3216761.*
Edelstahl, Schwarz
EEK: A++ bis A
230 V AC, 6 W, LED
3000 K, 450 lm
H 298, D 76, A 87
€ 210,10

3207760.* Schwarz
Erdspieß, inkl. 6 m
Zuleitung mit Stecker
EEK: A
16 W LED, 2800 K, 950 lm
L 195, B 120, H 350
€ 190,70



2622635.*
Weiß
EEK: A+,
12 W, LED
3000 K, 900 lm
H 90, L 217, B 143
IP 44 €
€ 32,00

Stahl verzinkt Silber, Kunststoff Weiß, LED-Modul tauschbar



3225424.*
EEK: A+,
2 x 2,5 W, LED
3000 K, 360 lm
H 270, A 115, L 170
€ 74,30



2623139.*
EEK: A+,
2 x 2,5 W, LED
3000 K, 360 lm
H 300, T 190, A 125
€ 80,90

**Bewegungs-
melder 90°**



3201043.*
Edelstahl
EEK: A++ bis E
2 x E27,
max. 57 W
H 355
B 165, A 100
€ 228,40



3216386.*
Grau
EEK: A
9 W, LED
4000 K, 490 lm
H 110
L 176, B 122
€ 58,00



3217298.*
Weiß
EEK: A++ bis A
10 W, LED
3000 K, 800 lm
H 155, B 133, T 75
€ 63,00

o. Abb.
3217304.*
Schwarz
3000 K, 800 lm
€ 63,00



3216495.*
Silber Metallic
EEK: A
18 W, LED
4000 K, 710 lm
H 120
L 210, B 130
€ 117,80



3217300.*
Weiß
EEK: A++ bis A
30 W, LED
3000 K, 2400 lm
H 252, B 227, T 86
€ 143,90

o. Abb.
3217306.*
Schwarz
3000 K, 2400 lm
€ 143,90



3216496.*
Silber Metallic
EEK: A
9 W, LED,
4000 K, 220 lm
H 87
L 227, B 141
€ 147,50



o. Abb.
3217302.*
Weiß
3000 K, 4000 lm
€ 190,40

o. Abb.
3217308.*
Schwarz
EEK: A++ bis A
50 W, LED
3000 K, 4000 lm
H 252, B 227, T 86
€ 190,40

o. Abb.
3217303.*
Weiß
5000 K, 4500 lm
€ 190,40

o. Abb.
3217309.*
Schwarz
5000 K, 4500 lm
€ 190,40



3207554.*
Edelstahl
EEK: A++ bis E
E27, max. 57 W
H 300, D 103, A 150
€ 224,90

6502208.*
Edelstahl
EEK: A++ bis E
E27, max. 57 W
H 700, D 103
€ 298,60

EEK: A++ bis E
für E-Spar und LED Leuchtmittel max. H 120



3204250*
Edelstahl
E27, max. 57 W
H 260, D 100, T 137
€ 178,40

3204251*
Edelstahl
E27, max. 57 W
H 600, D 100
€ 214,10

3204249*
Edelstahl
E27, max. 57 W
H 210, D 100
€ 130,80



3225431*
3,7 W, LED
LED austauschbar
8000 K, 280 lm
H 180, A 210, L 105
€ 74,30

Edelstahl klar, Weiß
EEK: A+

3225432*
3,7 W, LED
LED austauschbar
3000 K, 280 lm
H 450, D 105
€ 81,00

3225433*
3,7 W, LED
LED austauschbar
3000 K, 280 lm
H 1050, D 105
€ 108,00



1598706*
Silber metallic
EEK: A+
17,5 W, LED
3000 K, 590 lm
H 64, B 270, L 270
€ 320,30



3200819*
Edelstahl
EEK: A++ bis E
E27, max. 57 W
H 260, B 260, A 90
€ 197,50

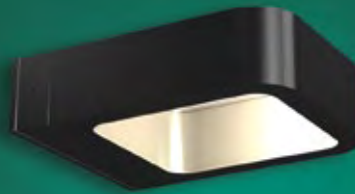

2622399*
Anthrazit metallic
EEK: A+
9 W, LED
3000 K, 290 lm
L 120, B 175, H 40
€ 160,10



2623148*
Alu Anthrazit,
Kunststoff transparent
EEK: A++ bis A
5,4 W, LED
3000 K, 510 lm
H 75, T 135, A 120
€ 94,90



2623144*
Stahl feuerverzinkt,
Kunststoff Weiß
EEK: A++ bis E
E27, 46 W
H 185, T 200, A 235
€ 53,90



3208514*
Stahl verzinkt, Silber
EEK: A++ bis E
E27, max. 57 W
D 285
€ 60,80



3216434*
Stahl verzinkt, Silber
EEK: A++ bis E
E27, max. 57 W
H 270, L 240
€ 33,20



3208554.*
Weiß
EEK: A++ bis A
26 W, 2 x 6 LED
5000 K, 1670 lm
H 195, B 176, L 140
€ 227,20

o. Abb.
3208555.*
Schwarz
€ 227,20



3208553.*
Schwarz
EEK: A++ bis A
18 W, 2 x 4 LED
5000 K, 1050 lm
H 195, B 132, L 137
€ 193,90

o. Abb.
3208551.*
Weiß
€ 193,90

mit Bewegungsmelder 140°



3208556.*
Weiß
EEK: A++ bis A
18 W, 8 x LED
5000 K, 1050 lm
H 216, B 132, L 137
€ 217,70

o. Abb.
3208557.*
Schwarz
€ 217,70

mit Bewegungsmelder 140°



3208558.*
Weiß
EEK: A++ bis A
26 W, 2 x 6 LED
5000 K, 1670 lm
H 216, B 176, L 140
€ 265,30

o. Abb.
3208559.*
Schwarz
€ 265,30



6501288* Edelstahl
EEK: A++ bis E
E27, max. 57 W
H 230, B 250, A 140
€ 110,60

Bewegungsmelder 140°



3208442.*
Weiß
EEK: A++ bis A
14 W, 6 x LED
5000 K, 770 lm
H 205, B 104, A 143
€ 166,60

o. Abb.
3208443.*
Schwarz
€ 166,60

o. Abb.
3213017.*
Schwarz
3000 K, 675 lm
€ 166,60

o. Abb.
3213016.*
Weiß
3000 K, 675 lm
€ 166,60



3208440.*
Schwarz
EEK: A++ bis A
14 W, 6 x LED
5000 K, 770 lm
H 205, B 104, A 143
€ 133,20

o. Abb.
3208441.*
Weiß
€ 133,20

o. Abb.
3213015.*
Schwarz
3000 K, 675 lm
€ 133,20

o. Abb.
3213013.*
Weiß
3000 K, 675 lm
€ 133,20



3211256.*
Anthrazit metallic
EEK: A+
23 W, LED
3000 K, 2200 lm
H 194, B 109, H 226
€ 342,80

o. Abb.
3211258.*
Silber metallic
20 W, LED
€ 342,80



3208453.*
Schwarz
EEK: A++ bis A
25 W, 12 x LED
5000 K, 1610 lm
H 205, B 184, A 143
€ 238,00

o. Abb.
3208455.*
Weiß
€ 238,00

o. Abb.
2702380.*
Schwarz
3000 K, 1630 lm
€ 236,80

o. Abb.
2702379.*
Weiß
3000 K, 1630 lm
€ 236,80



3208444.*
Weiß
EEK: A++ bis A
25 W, 12 x LED
5000 K, 1610 lm
H 205, B 184, A 143
€ 205,80

o. Abb.
3208452.*
Schwarz
€ 205,80

o. Abb.
2702378.*
Schwarz
3000 K, 1630 lm
€ 205,80

o. Abb.
2702377.*
Weiß
3000 K, 1630 lm
€ 205,80

3239683
Weiß
H 265
Bodenanker,
inkl. Adapter zur
Stabilisierung des
Strahlers in
weichem Erdreich
€ 30,90

o. Abb.
3235147
Schwarz
€ 30,90



3235139.*
Schwarz
EEK: A++ bis A
30 W, LED
3000 K, 2400 lm
H 290, B 227, T 86
€ 185,60

Bewegungsmelder 160°

o. Abb.
3235140.*
Weiß
€ 185,60



3235144.*
Weiß
EEK: A++ bis A
50 W, LED
3000 K, 4000 lm
H 290, B 227, T 86
€ 222,50

Bewegungsmelder 160°

o. Abb.
3235143.*
Schwarz
€ 222,50



3235136.*
Weiß
EEK: A++ bis A
10 W, LED
3000 K, 800 lm
H 210, B 133, T 75
€ 85,60

Bewegungsmelder 160°

o. Abb.
3235135.*
Schwarz
€ 85,60

3205236 *
Edelstahl
EEK: A++ bis B
20 W TC-DSE, E27
H 355, B 100, A 145
€ 254,60

3205239 *
Edelstahl
EEK: A++ bis B
20 W TC-DSE, E27
H 900, B 100
€ 556,90



2605684 *
Edelstahl/gebürstet
EEK: A++ bis E
E27, max. 46 W
L 315, B 100,
A 125
€ 208,10



3216444.*
Edelstahl
EEK: A+
2 x 2,5 W, LED
3000 K, 320 lm
H 195, L 80
€ 74,30



3216411.*
Edelstahl
EEK: A+
10 W, LED
3000 K, 770 lm
H 255, B 255,
A 130
€ 254,60



2623129*
Stahl verzinkt
silber-antik,
Kunststoff Weiß
EEK: A++ bis E
E27, 30 W
H 240, T 220, A 230
€ 53,90



3205289*
Edelstahl
EEK: A++ bis E
E27, max. 46 W
H 375, D 275,
A 325
€ 94,50



6500897*
Edelstahl
EEK: A++ bis E
E27, max. 57 W
H 900, D 103
€ 409,30

6501290 *
Edelstahl
EEK: A++ bis E
E27, max. 57 W
H 280, B 180, A 90
€ 228,40



6405600. * Weiß
EEK: A++ bis A
11,5 W, LED
3000 K, 474 lm
L 151, B 58, H 80
€ 94,00

o. Abb.
6405601. *
EEK: A++ bis A
4000 K, 488 lm
€ 94,00



6980280 *
Weiß
EEK: A bis E
E27, max. 57 W
D 265, H 125
€ 144,40

RGB, mit Akku, stufenloses Dimmen durch Fernbedienung

3233644. *
Weiß
4,5 W, LED
H 430, D 490
€ 405,40



3233641. *
Weiß
4,5 W, LED
H 800, D 250
€ 231,60



o. Abb.
3233642. *
Weiß
H 1200
€ 419,80

6980270 *
Weiß
EEK: A bis E
E27, max. 57 W
D 265, H 110
€ 128,70





3225594.*
Aluguss Anthrazit
EEK: A+
5,5 W, LED
3000 K, 550 lm
H 270, B 70, T 70,
A 105
€ 95,50

o. Abb.
3225595.*
Aluguss titanfarbig
€ 95,50



3225596.*
Aluguss Anthrazit
EEK: A+
5,5 W, LED
3000 K, 550 lm
H 270, B 70, T 70, A 110
€ 114,80

o. Abb.
3225597.*
Aluguss titanfarbig
€ 114,80

 **Bewegungsmelder 120°**



3225614.*
Aluguss Anthrazit
EEK: A+
5,5 W, LED
3000 K, 550 lm
H 1000, T 70, B 70
€ 140,30



3225617.*
Aluguss Anthrazit
EEK: A+
5,5 W, LED
3000 K, 550 lm
H 500, T 70, B 70
€ 108,40



3208494.*
Aluminium
EEK: A+
6 x 1 W, LED
3000 K, 480 lm
B 60, H 150, A 100
€ 179,60

Eckmontage möglich



2623130.*
Stahl verzinkt
silber-antik,
Kunststoff transparent
EEK: A++ bis E
E27, 46 W
H 375, T 200, A 170
€ 60,90

o. Abb.
2623128.*
Stahl verzinkt schwarz
EEK: A++ bis E
€ 53,90

Braun-Messing
E27, max. 57 W



3239320.*
EEK: A++ bis E
H 260, B 260,
A 330
€ 164,20

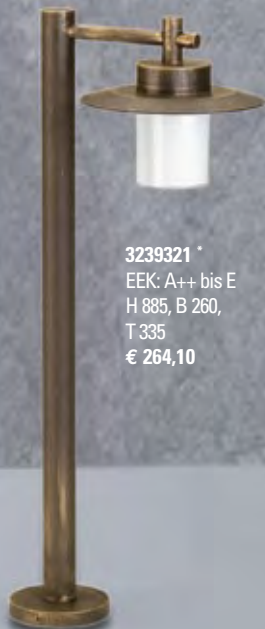

3239321.*
EEK: A++ bis E
H 885, B 260,
T 335
€ 264,10



3239676.*
Schwarz
EEK: A++ bis E
E27, max. 46 W
H 505, B 130, A 164,5
€ 296,30

3239681.*
EEK: A++ bis E
H 276, T 236,
A 129
€ 264,10



Schwarz
E27,
max. 46 W

3239677.*
EEK: A++ bis E
H 250, T 160,
A 110
€ 205,80



Bronze
E27,
max. 46 W



3239680.*
Schwarz
EEK: A++ bis E
H 330, B 205, A 240
€ 328,40



3239675.*
EEK: A++ bis E
H 220, T 116,
A 183
€ 360,50



3208260.*
Titanfarbig
EEK: A+
3 W, LED
3000 K, 210 lm
B 70, H 100, A 100
€ 102,80



3208261.*
Anthrazit
EEK: A+
3 W, LED
3000 K, 210 lm
B 70, H 100, A 100
€ 102,80



3208262.*
Weiß
EEK: A+
3 W, LED
3000 K, 210 lm
B 70, H 100, A 100
€ 102,80



3225610.*
Aluguss Weiß
EEK: A+
6,5 W, LED
3000 K, 640 lm
H 85, B 170, T 130
€ 127,20

o. Abb.
3225611.*
Aluguss
Anthrazit
€ 127,20

o. Abb.
3225612.*
Aluguss
titanfarbig
€ 127,20



3225619.*
Aluguss Weiß
EEK: A++
18 W, LED
3000 K, 1200 lm
H 50, B 250, L 250
€ 191,30

o. Abb.
3225620.*
Aluguss Anthrazit
€ 191,30



3239658.*
Aluguss Anthrazit
EEK: A+
9 W, LED
3000 K, 850 lm
B 230, H 72, A 56
€ 50,80



2622528.*
Schwarz
EEK: A++ bis A
10 W, LED, 3000 K, 800 lm
H 118, B 118, A 118
€ 177,30



2622527.*
Schwarz
EEK: A++ bis A
10 W, LED, 3000 K, 800 lm
H 118, B 118, A 118
€ 177,30



2623208.* Anthrazit
EEK: A
6 W, LED
3000 K, 550 lm
H 95, B 80, A 90
€ 82,00



2623209.* Anthrazit
EEK: A
2 x 12 W, LED
3000 K, 1100 lm
H 105, B 80, A 92
€ 94,00



3208258.* Titanfarbig
EEK: A+
2 x 3 W, LED
3000 K, 180 lm
B 140, H 140, A 50
€ 109,30

o. Abb.
3208259.*
Anthrazit
€ 109,30



3225445.* Anthrazit
EEK: A+
2 x 3 W, LED
3000 K, 460 lm
H 90, B 65, A 170
€ 136,80

o. Abb.
3208484.*
Grau
€ 136,80





Aluguss Schwarz,
Acrylglas satiniert



3239685.*
EEK: A+
16 W, LED
3000 K, 1600 lm
H 190, B 260, T 55
€ 305,80

3239684.*
EEK: A+
16 W, LED
3000 K, 1600 lm
D 230, T 55
€ 305,80



2622400.*
Anthrazit metallic
EEK: A+
3 W, LED
3000 K, 110 lm
L 80, B 66, H 75
€ 89,00



3208495.*
Aluminium
EEK: A+
5 W, LED
3000 K, 340 lm
D 150, A 105
€ 210,60



3208480.*
Galvanisierter Stahl
EEK: A++ bis E
2 x GU10, max. 35 W
H 145, B 235, A 90
€ 64,20

o. Abb.
3208479.*
Weiß
€ 55,90

o. Abb.
3208481.*
Schwarz
€ 55,90



3208477.*
Galvanisierter Stahl
EEK: A++ bis E
GU10, max. 35 W
H 145, B 135, A 90
€ 51,10

o. Abb.
3208476.*
Weiß
€ 39,20

o. Abb.
3208478.*
Schwarz
€ 39,20

**Aluguss Anthrazit,
Acryl Weiß**
alle EEK: A+, IP 54



3232352.*
2 x 4,5 W, LED
3000 K, 2 x 450 lm
H 250, B 110, T 105
€ 88,00



Bewegungsmelder 120°

3232353.*
2 x 4,5 W, LED
3000 K, 2 x 450 lm
H 280, B 110, T 120
€ 108,40



3232356.*
2 x 5,5 W, LED
3000 K, 2 x 600 lm
H 1000, B 155, T 75
€ 152,70

3232357.*
2 x 5,5 W, LED
3000 K, 2 x 600 lm
H 150, B 155, T 75
€ 114,80



0644812.*
Aluguss Weiß, PVC Weiß
EEK: A
13,5 W, LED
3000 K, 1000 lm
B 300, L 300, A 95
€ 205,50

o. Abb.
0644813.*
Anthrazit
€ 205,50



2623203.*
Weiß
EEK: A
4 W, LED
3000 K, 240 lm
D 130, A 180
€ 94,00

o. Abb.
2623204.*
Anthrazit
€ 94,00



2615015.*
Silber,
Glas Opal glänzend
EEK: A+
10 W, LED
3000 K, 750 lm
H 125, B 250, A 116
€ 142,70

o. Abb.
2615014.*
Weiß
€ 142,70



3208251.*
Titanfarbig,
Kunststoff Weiß
2 x 4 W LED, E14
3000 K, 2 x 320 lm
H 330, B 85, A 115
€ 116,50

o. Abb.
3208255.*
Anthrazit
€ 116,50

Titanfarbig,
Kunststoff Weiß,
alle EEK: A+



3208252.*
4 W, LED, E14
3000 K, 320 lm
H 170, B 85, A 115
€ 67,10

o. Abb.
3208254.*
Anthrazit
€ 67,10



3208253.*
4 W, LED, E14
3000 K, 320 lm
H 800, B 85, T 85
€ 109,30

o. Abb.
3208257.*
Anthrazit
€ 109,30

3208250.*
4 W, LED, E14
3000 K, 320 lm
H 300, B 85, T 85
€ 81,80

o. Abb.
3208256.*
Anthrazit
€ 81,80



2615012.*
Weiß
EEK: A++
4 W, LED
3000 K, 300 lm
H 205, B 205, A 74
€ 118,90

o. Abb.
2615013.*
Silber
€ 118,90

Deckel
magnet-haftend



3208244.*
Titanfarbig
EEK: A+
2 x 4 W, LED
3000 K, 275 lm
H 70, B 60, A 120
€ 116,50

o. Abb.
3208243.*
Anthrazit
€ 116,50

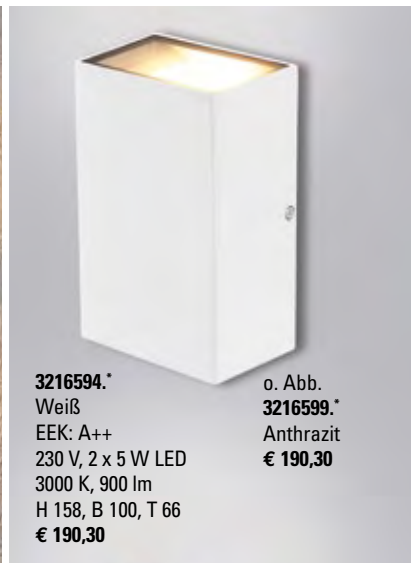

3216594.*
Weiß
EEK: A++
230 V, 2 x 5 W LED
3000 K, 900 lm
H 158, B 100, T 66
€ 190,30

o. Abb.
3216599.*
Anthrazit
€ 190,30



3216598.* Anthrazit
EEK: A++
230 V, 2 x 5 W LED
3000 K, 900 lm
H 158, B 100, T 66
€ 190,30

o. Abb.
3216593.*
Weiß
€ 190,30



2623207*
 Anthrazit
 EEK: A++ bis A
 2 x GU10, 6 W, LED
 H 225, B 115, T 102
 für Energiesparlampen geeignet
€ 94,00

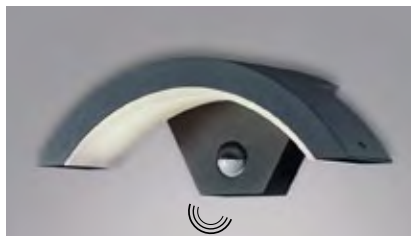

Bewegungsmelder 120 °

0644778.*
 Aluguss Anthrazit
 EEK: A+
 6 W, LED
 3000 K, 420 lm
 H 100, B 300, A 90
€ 164,20



0644776.*
 Aluguss Anthrazit
 EEK: A+
 6 W, LED
 3000 K, 420 lm
 H 100, B 300, A 90
€ 121,80



3225608.*
 Aluguss Anthrazit
 EEK: A++
 2 x 3 W, LED
 3000 K, 260 lm
 H 200, B 90, A 65
€ 70,00



3208239.*
 Anthrazit,
 Kunststoff Weiß
 EEK: A+
 8 W, LED
 3000 K, 700 lm
 H 1100, B 200, T 117
€ 178,10

3208238.*
 Anthrazit,
 Kunststoff Weiß
 EEK: A+
 8 W, LED
 3000 K, 700 lm
 H 220, B 148, A 124
€ 123,10

3208237.*
 Anthrazit,
 Kunststoff Weiß
 EEK: A+
 8 W, LED
 3000 K, 700 lm
 H 600, B 200
 T 117
 Anthrazit
€ 161,70



3216489*
 Anthrazit
 EEK: A++ bis E
 GU10, max. 35 W
 H 135
 B 65, A 100
€ 60,60



3216488*
 Anthrazit
 EEK: A++ bis E
 2 x GU10, max. 35 W
 H 200
 B 65, A 100
€ 70,20

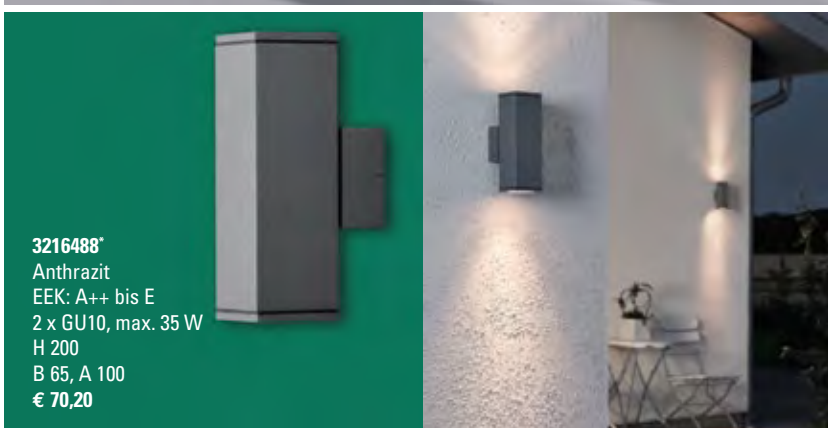

**Individuell
 verstellbarer
 Lichtaustritt
 an zwei Seiten
 von 0 - 90°**



2623210.* Anthrazit
 EEK: A
 2 x 12 W, LED
 3000 K, 720 lm
 H 172, B 82, A 128
€ 117,80

2623206.*

Anthrazit

EEK: A+

2 x 3 W, LED

3000 K, 460 lm

H 135, B 130, A 110

€ 117,80

o. Abb.

2623205.*

Grau

EEK: A++ bis A

€ 117,80

3216465.*

Anthrazit

EEK: A++ bis A

6 W, LED

3000 K, 113 lm

H 100, B 100, L 100

€ 148,70

o. Abb.

3216466.*

EEK: A++ bis A

4000 K, 141 lm

€ 148,70

3239655.*

Weiß

EEK: A++

2 x 2,5 W, LED

3000 K, 2 x 260 lm

H 90, B 115, A 30

€ 50,80

o. Abb.

3239656.*

Anthrazit

EEK: A++

€ 50,80

o. Abb.

3239657.*

Titanfarbig

EEK: A++

€ 50,80

3208072.*

Edelstahl,
Glas Opal

EEK: A+

10 W, LED

3000 K, 770 lm

H 285, B 180, A 85

€ 332,00

Individuell verstellbarer Lichtaustritt an zwei Seiten von 0 - 120°



2702382.*

Anthrazit

EEK: A++ bis A

50 LED, 24 W

3000 K, 1930 lm

H 65, B 200,

L 200

€ 267,70

2702384.*

Anthrazit

EEK: A++ bis A

25 LED, 13,5 W

3000 K, 960 lm

H 65, B 200,

L 200

€ 196,30

Aluguss Anthrazit Bewegungsmelder 120° 9 W, LED



3225593.*

EEK: A+

3000 K, 900 lm

H 160, B 100, T 105

€ 165,70

o. Abb.

3232351.*

EEK: A+

ohne Bewegungsmelder

€ 140,30

3225613.*

EEK: A+

3000 K, 900 lm

H 1000, B 100, T 80

€ 216,80

o. Abb.

3239660.*

EEK: A+

H 1000, B 140, A 125

ohne Bewegungsmelder

€ 191,20

3225616.*

EEK: A+

3000 K, 900 lm

H 500, B 100, T 80

€ 191,30

o. Abb.

3239661.*

EEK: A+

H 500, B 140, A 125

ohne Bewegungsmelder

€ 165,70

Individuell verstellbarer Lichtaustritt an zwei Seiten von 0 - 120°



3216491.*

Anthrazit

EEK: A+

2 x 3 W, LED

3000 K, 334 lm

B 80, H 170, A 110

€ 117,80

o. Abb.

3216490.*

Grau

€ 117,80





230 V -1,2 W, P-LED WS
mit Stahl-Einbauhülle

1422423.*
Edelstahlfront
EEK: A+
6000 K, 90 lm
ET 82, LA 59
H 83, D 64
€ 118,90

2600313.* kalt-weiß € 29,60
2606114.* warm-weiß € 29,60

Edelstahl V4A
EEK: A
12 V DC - 0,2 W, LED
H 29, B 18, ET 30, LA 13
mit 2 m Gummileitung
weitere Farben auf Anfrage



2601613.*
LED warmweiß
5 m Gummileitung
€ 47,50

Edelstahl V4A
EEK: A
12 V DC - 0,3 W,
H 33, B 18, ET 32, LA 13



1422424.*
Edelstahlfront
EEK: A+
6000 K, 90 lm
ET 82, LA 59
H 83, B 63
€ 130,80



mit Kunststoff-Einbauhülle

3200888.*
Edelstahlfront
schwenkbar
EEK: A++ bis E
GU10, max. 35 W
H 175, D 150
ET 196, A 143
€ 190,30

mit Kunststoff
Einbauhülle
und Kunststoff
Gehäuse

Schwenkbereich 15°



3204824.*
Edelstahl V2A
EEK: A++ bis E
GU10, max. 35 W
H 115, LA 102, ET 120
€ 74,90



2603669.*
Edelstahlfront
EEK: A++ bis E
GU10, max. 35 W
H 115, D 120
ET 120, A 102
mit Kunststoff
Einbauhülle
€ 63,00

Edelstahl, inkl. Alu-Einbauhülle



3205533.* EEK: A+
2 W, LED, 3000 K, 82 lm
H 73, L 63, B 63,
LA 59, ET 82
€ 130,80

3205532.* EEK: A+
2 W, LED, 3000 K, 82 lm
H 73, D 63,
LA 59, ET 83
€ 118,90

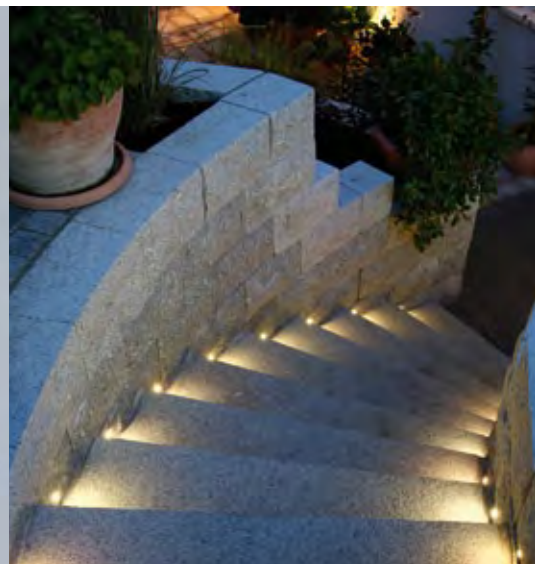

3216596.*
Anthrazit
EEK: A+
230 V
2 x 12 W LED, wws
3000 K, 1700 lm
H 222, T 135
€ 273,60



3216472.*
Grau metallic
EEK: A++ bis A
23,5 W, LED
3000 K, 623 lm
L 300, B 100, A 100
€ 213,00

o. Abb.
3216474.*
Grau metallic
32,5 W, LED
3000 K, 1044 lm
€ 291,50

3216470.*
Grau metallic
EEK: A++ bis A
12,5 W, LED
3000 K, 407 lm
L 200, B 100, A 100
€ 141,60

o. Abb.
3216468.*
Anthrazit metallic
12,5 W, LED
3000 K, 407 lm
€ 141,60

o. Abb.
3216467.*
Anthrazit metallic
12,5 W, LED
4000 K, 448 lm
€ 141,60

Bestens geeignet für die
Umrüstung „Light-Balls“



1403433* RGB
EEK: A
5 W, E27,
B 60, H 113
€ 95,10



„Strom an / aus
durch
Funktechnik“

1421527* Granitgrau
4-fach Steckdosenstein
IP 44 für den Außen-
bereich
5 m Anschlussleitung
H 240, B 250, T 250
€ 154,60



1421550* Granitgrau
3-fach Funk-Steckdosenstein,
2-Kanal Empfänger
IP 44 für den Außenbereich
5 m Anschlussleitung
H 240, B 250, T 250
€ 475,90

1421552* Anthrazit
8-Kanal Funk-Handsender
Reichweite ca. 50 m
H 15, L 100, B 31
€ 142,70

„Light-Ball“

**Licht-Kugel,
Weiß**
hochwertiges ca. 5 mm
starkes Polyethylen,
inkl. Erdspieß
und 1,8 m Zuleitung

3208505*
Light-Ball-Einschlaghülle
€ 23,70

1421363*
EEK: A++
bis E, E27,
max. 46 W
D 300
€ 285,50

1421368*
EEK: A++
bis E, E27,
max. 46 W
D 400
€ 345,00

1421369*
EEK: A++
bis E, E27,
max. 46 W
D 500
€ 404,50



1421365*
EEK: A++
bis E, E27,
max. 46 W
D 600
€ 475,90

0644772.*

Aluguss Anthrazit
EEK: A+
5 W, LED
3000 K, 330 lm
B 120, H 45, A 145
€ 102,80



Als Wand- und Deckenleuchte verwendbar

0644786.*

Aluguss Weiß,
PVC Weiß
EEK: A+
3,5 W, LED
3000 K, 330 lm
B 140, H 140, A 65
€ 75,40



o. Abb.
0644787.*
Anthrazit
€ 75,40

o. Abb.
0644788.*
Titanfarbig
€ 75,40

**3225598.***

Aluguss Weiß
EEK: A+
6 W, E27
3000 K, 470 lm
H 285
B 150, A 100
€ 84,20

o. Abb.
3225599.*
Anthrazit
€ 84,20

3239659.*

Aluguss Anthrazit
EEK: A+
9 W, LED
3000 K, 850 lm
H 211, B 161, A 59
mit Dämmerungs-
schalter und
Hausnummern-Set
€ 101,80

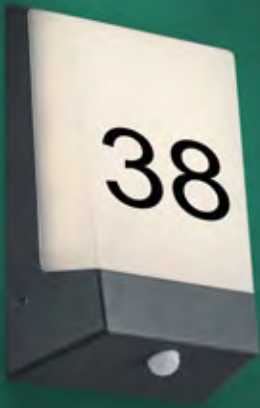
**2615178.***

Edelstahl
EEK: A++ bis A
3 W, LED
2700 K, 270 lm
H 205, B 162, A 65
€ 44,90



o. Abb.
3225457.*
Anthrazit
€ 44,90

3225460.*

Anthrazit
EEK: A++ bis A
3 W, LED
2700 K, 270 lm
H 205, B 162
€ 67,40



o. Abb.
3217101.*
Edelstahl
€ 67,40

Bewegungsmelder
140°

2622402.*

Anthrazit metallic
EEK: A+
12 W, LED
3000 K, 390 lm
H 650, L 108, B 108
€ 267,00

**2622397.***

Anthrazit metallic
EEK: A+
18 W, LED
3000 K, 690 lm
H 250, L 110, B 103
€ 154,30

**2623261.***

Edelstahl
EEK: A++ bis A
2,1 W, LED
2700 K, 200 lm
H 190, B 51, T 72
€ 47,60





3216341.*
Weiß
EEK: A++ bis A
40 W, LED
2800 lm
L 210, B 171, H 228
€ 179,60

o. Abb.
3216342.*
Grau
€ 179,60



3216340.*
Grau
EEK: A++ bis A
23 W, LED
1600 lm
L 189, B 167, H 202
€ 122,50

o. Abb.
3216339.*
Weiß
€ 122,50



2615042.*
Weiß,
Polycarbonat
EEK: A+
27 W, LED, IP 65,
LED Platine
austauschbar
3000 K, 2400 lm
H 100, B 300, L 300
€ 178,50



3225602.*
Aluguss Weiß
EEK: A++
3,5 W, LED
3000 K, 330 lm
H 117, B 120, A 139
€ 70,00

o. Abb.
3225603.*
Aluguss Anthrazit
€ 70,00



6501299.*
Edelstahl
EEK: A
2 x 9 W, TC-S
B 260, A 60
€ 261,80



6501755.*
Edelstahl
EEK: A
2 x 11 W, TC-S
H 320, B 225, A 65
€ 215,30

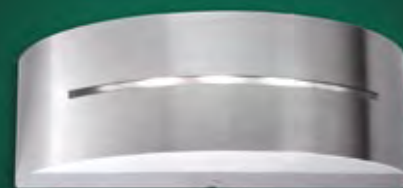

3216505.*
Edelstahl
EEK: A++ bis A
7,5 W, LED
2700 K, 270 lm
H 64, L 205
€ 111,80



2623155.*
Alugussrahmen Schwarz,
Abdeckung Polycarbonat
EEK: A+
23 W, LED
3000 K, 2300 lm
H 240, B 240, A 50
IP54
€ 140,40

o. Abb.
2623156.*
Alugussrahmen Weiß,
Abdeckung Polycarbonat
€ 140,40



2623198.*
Weiß matt
EEK: A++ bis A
8 W, LED
3000 K, 800 lm
D 180, A 35
€ 213,00

o. Abb.
2623199.*
Graphit
€ 213,00



32623132.*
Aluguss edelstahl,
Kunststoff Weiß
EEK: A++ bis A
2 x 3 W, LED
3000 K, 500 lm
H 95, T 85, A 125
€ 94,40



3208518.*
Edelstahl
EEK: A+
2,5 W,
GU10 LED
4000 K, 200 lm
H 160, A 95
€ 47,30



2622422.*
EEK: A++ bis A
16 W, LED
3000 K, 1270 lm
H 84,5, D 320
€ 94,00



3200818.*
Edelstahl
EEK: A++ bis E
E27, max. 57 W
H 280, B 180,
A 85
€ 202,30



6502547.*
Silber
EEK: A++ bis E
E27, max. 57 W
H 300, B 200,
A 95
€ 223,70



6501847.*
Edelstahl
EEK: A++ bis E
E27, max. 57 W
H 280, B 180,
A 105
€ 179,60



3212604.*
Silber metallic
EEK: A+
8,5 W LED
4000 K, 420 lm
D 268, H 91
€ 213,90

o. Abb.
3212601.*
Aluminium
4000 K, 380 lm
mit integriertem
HF-Bewegungs-
melder 
€ 313,90



z. B. für Treppenstufen

3231684.*
Silber metallic
EEK: A+
4 W, LED
3000 K, 60 lm
L 120, B 120,
H 24
€ 236,40

o. Abb.
3231682.*
Anthrazit
metallic
€ 236,40



3208420.*
Edelstahl
EEK: A++ bis B
TC-DSE, max. 20 W
H 385, B 80, A 120
€ 217,70

3208422.*
Edelstahl
EEK: A++ bis B
TC-DSE, max. 20 W
H 900, D 80
€ 408,10

3208421.*
Edelstahl
EEK: A++ bis B
TC-DSE, max. 20 W
H 500, D 80
€ 342,70

3203033.* Edelstahl
EEK: A++ bis A
230 V AC, 3,6 W
3100 K, 300 lm
D 105, ET 155, BA 92
€ 269,50

3203036.* Edelstahl
EEK: A++ bis A
230 V AC, 3,6 W
3100 K, 300 lm
D 100 x 100, ET 155, BA 92
€ 269,50



**Von Ihrem
Elektro-Fachhändler**

* Die vollständige Information zu energieverbrauchsrelevanten Daten sowie ggf. weitere Produktdaten erhalten Sie über die Internetseite www.sonepar.de/eu-label. Durch Eingabe der Artikelnummer können Sie die produktspezifischen, insbesondere energieverbrauchsrelevanten Informationen herunterladen. Bedeutung der Angabe z. B. „EEK: A++ bis E“: Die Energieeffizienzklasse richtet sich bei diesen Produkten nach der Wahl des Leuchtmittels. Ein LED-Leuchtmittel hat eine höhere Effizienzklasse als eine Kompaktsparlampe.

Unverbindliche Preisempfehlung einschl. gesetzl. MwSt. Preise sind Stückpreise. – Farbabweichungen, Irrtümer, Preis- und Modelländerungen und Druckfehler vorbehalten. **Gültig bis 31. August 2018.** Leuchten ohne Leuchtmittel. Die Produktangaben sind ausschließlich solche des Herstellers. Die Sonepar Deutschland GmbH und die mit ihr verbundenen Unternehmen haften nicht für Herstellerangaben und sich daraus ergebende Rechtsfolgen. Alle Maße in mm. Dieses Prospekt zeigt Ihnen nur eine Auswahl aus unserem großen Leuchtenangebot. **Sollten Sie Ihre Wunschleuchte nicht gefunden haben, fragen Sie uns. Wir nehmen uns gerne Zeit für Sie.**